

# PM25RLB120

FLAT-BASE TYPE  
INSULATED PACKAGE

## PM25RLB120



### FEATURE

- a) Adopting new 5th generation IGBT (CSTBT) chip, which performance is improved by 1 $\mu$ m fine rule process.  
For example, typical  $V_{ce(sat)}=1.9V$  @ $T_j=125^\circ C$
- b) I adopt the over-temperature conservation by  $T_j$  detection of CSTBT chip, and error output is possible from all each conservation upper and lower arm of IPM.
- c) Current rating of brake part increased.  
60% for the current rating of inverter part.
  - 3 $\phi$  25A, 1200V Current-sense IGBT type inverter
  - 15A, 1200V Current-sense regenerative brake IGBT
  - Monolithic gate drive & protection logic
  - Detection, protection & status indication circuits for, short-circuit, over-temperature & under-voltage (P-Fo available from upper arm devices)
  - Acoustic noise-less 3.7kW class inverter application
  - UL Recognized Yellow Card No.E80276(N)  
File No.E80271

## APPLICATION

General purpose inverter, servo drives and other motor controls

### PACKAGE OUTLINES

Dimensions in mm

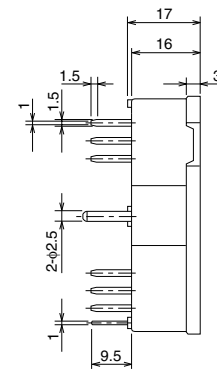
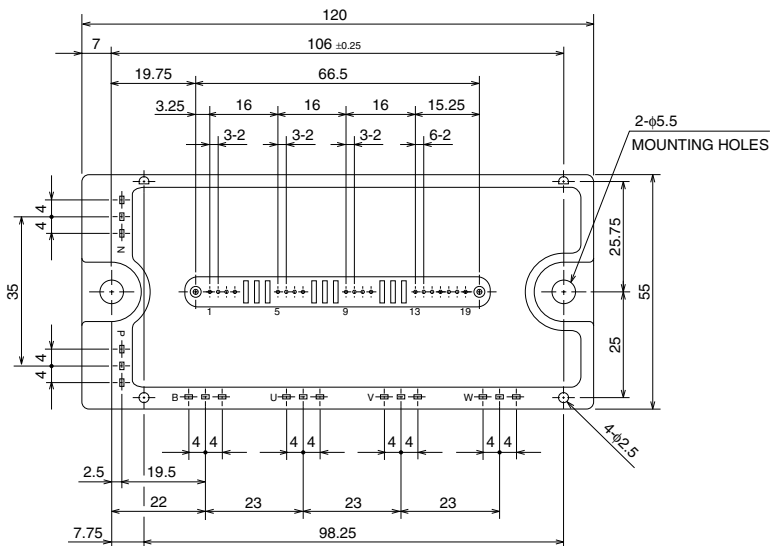

#### Terminal code

- |         |          |
|---------|----------|
| 1. VUPC | 11. WP   |
| 2. UFO  | 12. VWP1 |
| 3. UP   | 13. VNC  |
| 4. VUP1 | 14. VN1  |
| 5. VVPC | 15. Br   |
| 6. VFO  | 16. UN   |
| 7. VP   | 17. VN   |
| 8. VVP1 | 18. WN   |
| 9. VVPC | 19. Fo   |
| 10. WFO |          |

# PM25RLB120

FLAT-BASE TYPE  
INSULATED PACKAGE

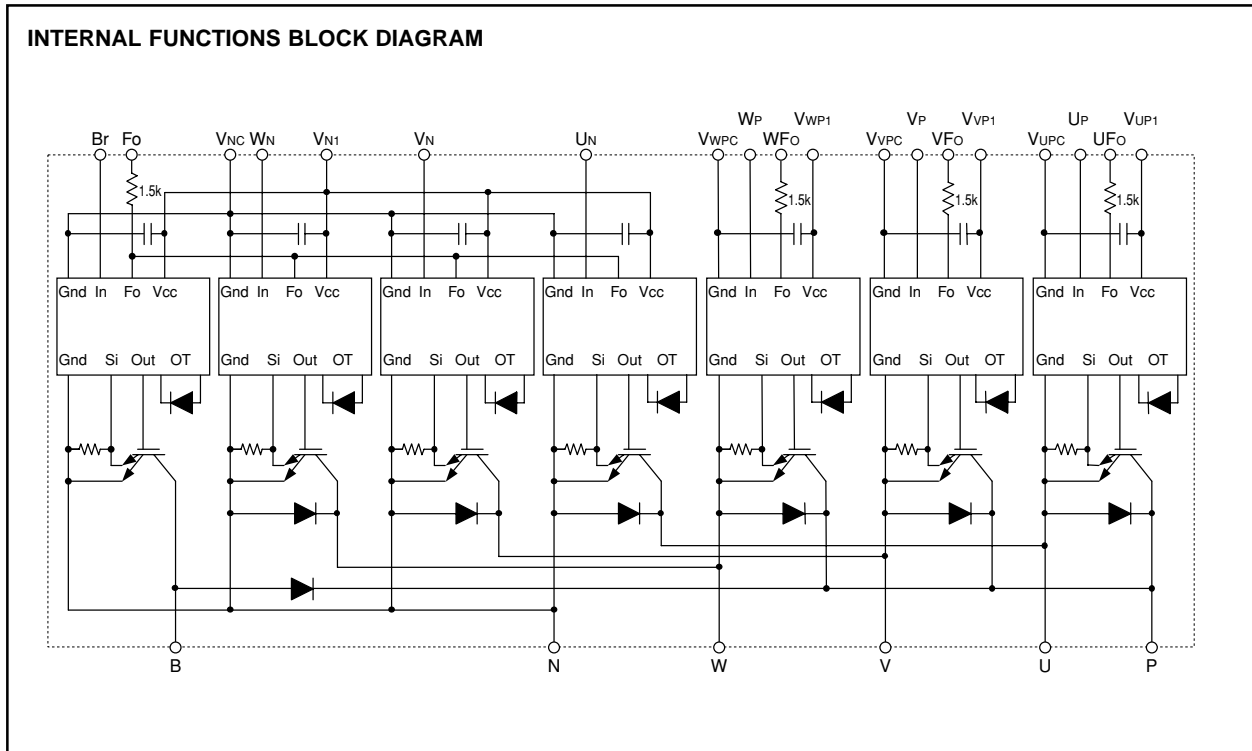

**MAXIMUM RATINGS** (Tj = 25°C, unless otherwise noted)

**INVERTER PART**

Symbol	Parameter	Condition	Ratings	Unit
VCES	Collector-Emitter Voltage	VD = 15V, Vcin = 15V	1200	V
±IC	Collector Current	Tc = 25°C	25	A
±ICP	Collector Current (Peak)	Tc = 25°C	50	A
PC	Collector Dissipation	Tc = 25°C (Note-1)	150	W
Tj	Junction Temperature		-20 ~ +150	°C

**BRAKE PART**

Symbol	Parameter	Condition	Ratings	Unit
VCES	Collector-Emitter Voltage	VD = 15V, Vcin = 15V	1200	V
IC	Collector Current	Tc = 25°C	15	A
ICP	Collector Current (Peak)	Tc = 25°C	30	A
PC	Collector Dissipation	Tc = 25°C (Note-1)	130	W
VR(DC)	FWDi Rated DC Reverse Voltage	Tc = 25°C	1200	V
IF	FWDi Forward Current	Tc = 25°C	15	A
Tj	Junction Temperature		-20 ~ +150	°C

**CONTROL PART**

Symbol	Parameter	Condition	Ratings	Unit
VD	Supply Voltage	Applied between : VUP1-VUPC VVP1-VVPC, VWP1-VWPC, VN1-VNC	20	V
Vcin	Input Voltage	Applied between : UP-VUPC, VP-VVPC WP-VWPC, UN • VN • WN • Br-VNC	20	V
VFO	Fault Output Supply Voltage	Applied between : UFO-VUPC, VFO-VVPC, WFO-VWPC FO-VNC	20	V
IFO	Fault Output Current	Sink current at UFO, VFO, WFO, FO terminals	20	mA

# PM25RLB120

FLAT-BASE TYPE  
INSULATED PACKAGE

## TOTAL SYSTEM

Symbol	Parameter	Condition	Ratings	Unit
VCC(PROT)	Supply Voltage Protected by SC	V <sub>D</sub> = 13.5 ~ 16.5V, Inverter Part, T <sub>j</sub> = +125°C Start	800	V
VCC(surge)	Supply Voltage (Surge)	Applied between : P-N, Surge value	1000	V
T <sub>stg</sub>	Storage Temperature		-40 ~ +125	°C
V <sub>iso</sub>	Isolation Voltage	60Hz, Sinusoidal, Charged part to Base, AC 1 min.	2500	V <sub>rms</sub>

## THERMAL RESISTANCES

Symbol	Parameter	Condition	Limits			Unit
			Min.	Typ.	Max.	
R <sub>th(j-c)Q</sub>	Junction to case Thermal Resistances	Inverter IGBT (per 1 element) (Note-1)	—	—	0.83*	°C/W
R <sub>th(j-c)F</sub>		Inverter FWDi (per 1 element) (Note-1)	—	—	1.36*	
R <sub>th(j-c)Q</sub>		Brake IGBT (Note-1)	—	—	0.96*	
R <sub>th(j-c)F</sub>		Brake FWDi (Note-1)	—	—	1.82*	
R <sub>th(c-f)</sub>	Contact Thermal Resistance	Case to fin, (per 1 module) Thermal grease applied (Note-1)	—	—	0.038	

\* If you use this value, R<sub>th(f-a)</sub> should be measured just under the chips.

(Note-1) T<sub>c</sub> (under the chip) measurement point is below.

(Unit : mm)

axis	arm	UP		VP		WP		UN		VN		WN		Br	
		IGBT	FWDi	IGBT	FWDi	IGBT	FWDi	IGBT	FWDi	IGBT	FWDi	IGBT	FWDi	IGBT	FWDi
X		29.0	29.3	65.0	65.5	85.6	85.9	37.8	37.5	55.2	55.7	75.8	75.3	19.0	22.3
Y		-7.1	1.5	-7.1	2.0	-7.1	2.0	5.1	-4.5	5.1	-4.5	5.1	-4.5	-7.3	6.6

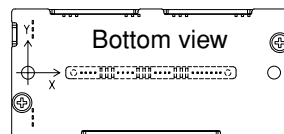

## ELECTRICAL CHARACTERISTICS (T<sub>j</sub> = 25°C, unless otherwise noted)

### INVERTER PART

Symbol	Parameter	Condition	Limits			Unit
			Min.	Typ.	Max.	
V <sub>CE(sat)</sub>	Collector-Emitter Saturation Voltage	V <sub>D</sub> = 15V, I <sub>c</sub> = 25A V <sub>CIN</sub> = 0V (Fig. 1)				V
			T <sub>j</sub> = 25°C	—	1.8	
V <sub>EC</sub>	FWDi Forward Voltage	-I <sub>c</sub> = 25A, V <sub>D</sub> = 15V, V <sub>CIN</sub> = 15V (Fig. 2)	—	2.5	3.5	V
t <sub>on</sub>	Switching Time	V <sub>D</sub> = 15V, V <sub>CIN</sub> = 0V↔15V V <sub>CC</sub> = 600V, I <sub>c</sub> = 25A T <sub>j</sub> = 125°C Inductive Load (Fig. 3,4)	0.5	1.0	2.5	μs
t <sub>rr</sub>			—	0.5	0.8	
t <sub>c(on)</sub>			—	0.4	1.0	
t <sub>off</sub>			—	2.0	3.0	
t <sub>c(off)</sub>			—	0.7	1.2	
I <sub>CES</sub>	Collector-Emitter Cutoff Current	V <sub>CE</sub> = V <sub>CES</sub> , V <sub>CIN</sub> = 15V (Fig. 5)				mA
			T <sub>j</sub> = 25°C	—	—	
			T <sub>j</sub> = 125°C	—	—	10

## PM25RLB120

FLAT-BASE TYPE  
INSULATED PACKAGE

## BRAKE PART

Symbol	Parameter	Condition	Limits			Unit	
			Min.	Typ.	Max.		
V <sub>CE(sat)</sub>	Collector-Emitter Saturation Voltage	V <sub>D</sub> = 15V, I <sub>C</sub> = 15A V <sub>CIN</sub> = 0V (Fig. 1)	T <sub>J</sub> = 25°C	—	1.8	2.3	V
			T <sub>J</sub> = 125°C	—	1.9	2.4	
V <sub>FM</sub>	FWDi Forward Voltage	I <sub>F</sub> = 15A (Fig. 2)	—	2.5	3.5	V	
I <sub>CES</sub>	Collector-Emitter Cutoff Current	V <sub>CE</sub> = V <sub>CES</sub> , V <sub>CIN</sub> = 15V (Fig. 5)	T <sub>J</sub> = 25°C	—	—	1	mA
			T <sub>J</sub> = 125°C	—	—	10	

## CONTROL PART

Symbol	Parameter	Condition	Limits			Unit	
			Min.	Typ.	Max.		
I <sub>D</sub>	Circuit Current	V <sub>D</sub> = 15V, V <sub>CIN</sub> = 15V	V <sub>N1-VNC</sub>	—	20	30	mA
			V <sub>P1-VPC</sub>	—	5	10	
V <sub>th(ON)</sub>	Input ON Threshold Voltage	Applied between : UP-VUPC, VP-VVPC, WP-VWPC UN • VN • WN • Br-VNC	1.2	1.5	1.8	V	
V <sub>th(OFF)</sub>	Input OFF Threshold Voltage		1.7	2.0	2.3		
SC	Short Circuit Trip Level	-20 ≤ T <sub>J</sub> ≤ 125°C, V <sub>D</sub> = 15V (Fig. 3,6)	Inverter part	50	—	—	A
			Brake part	30	—	—	
t <sub>off(SC)</sub>	Short Circuit Current Delay Time	V <sub>D</sub> = 15V (Fig. 3,6)	—	0.2	—	μs	
OT	Over Temperature Protection	V <sub>D</sub> = 15V Detect T <sub>J</sub> of IGBT chip	Trip level	135	145	—	°C
			Reset level	—	125	—	
UV	Supply Circuit Under-Voltage Protection	-20 ≤ T <sub>J</sub> ≤ 125°C	Trip level	11.5	12.0	12.5	V
			Reset level	—	12.5	—	
I <sub>FO(H)</sub>	Fault Output Current	V <sub>D</sub> = 15V, V <sub>FO</sub> = 15V (Note-2)	—	—	0.01	mA	
I <sub>FO(L)</sub>			—	10	15		
t <sub>FO</sub>	Minimum Fault Output Pulse Width	V <sub>D</sub> = 15V (Note-2)	1.0	1.8	—	ms	

(Note-2) Fault output is given only when the internal SC, OT & UV protections schemes of either upper or lower arm device operate to protect it.

## MECHANICAL RATINGS AND CHARACTERISTICS

Symbol	Parameter	Condition	Limits			Unit
			Min.	Typ.	Max.	
—	Mounting torque	Mounting part screw : M5	2.5	3.0	3.5	N • m
—	Weight	—	—	340	—	g

## RECOMMENDED CONDITIONS FOR USE

Symbol	Parameter	Condition	Recommended value	Unit
V <sub>CC</sub>	Supply Voltage	Applied across P-N terminals	≤ 800	V
V <sub>D</sub>	Control Supply Voltage	Applied between : VUP1-VUPC, VVP1-VVPC VWP1-VWPC, VN1-VNC (Note-3)	15.0 ± 1.5	V
V <sub>CIN(ON)</sub>	Input ON Voltage	Applied between : UP-VUPC, VP-VVPC, WP-VWPC UN • VN • WN • Br-VNC	≤ 0.8	V
V <sub>CIN(OFF)</sub>	Input OFF Voltage		≥ 9.0	
f <sub>PWM</sub>	PWM Input Frequency	Using Application Circuit of Fig. 8	≤ 20	kHz
t <sub>dead</sub>	Arm Shoot-through Blocking Time	For IPM's each input signals (Fig. 7)	≥ 2.5	μs

(Note-3) With ripple satisfying the following conditions: dv/dt swing ≤ ±5V/μs, Variation ≤ 2V peak to peak

# PM25RLB120

FLAT-BASE TYPE  
INSULATED PACKAGE

## PRECAUTIONS FOR TESTING

1. Before applying any control supply voltage ( $V_D$ ), the input terminals should be pulled up by resistors, etc. to their corresponding supply voltage and each input signal should be kept off state.  
After this, the specified ON and OFF level setting for each input signal should be done.
2. When performing "SC" tests, the turn-off surge voltage spike at the corresponding protection operation should not be allowed to rise above  $V_{CES}$  rating of the device.  
(These test should not be done by using a curve tracer or its equivalent.)

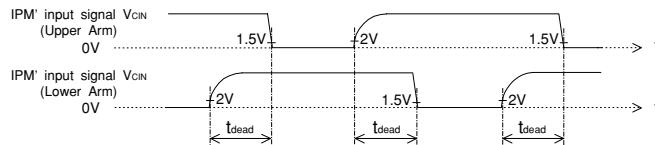
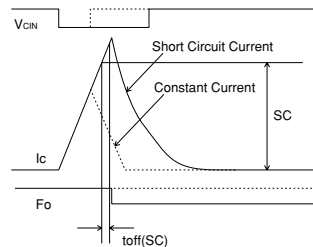
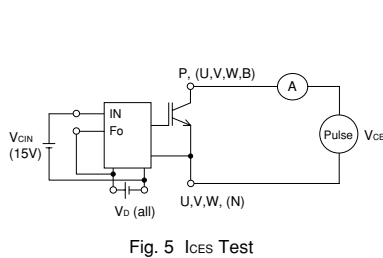
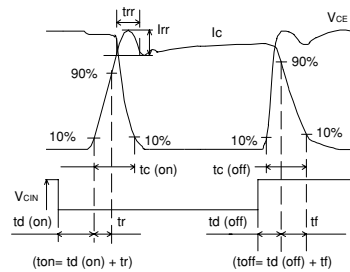
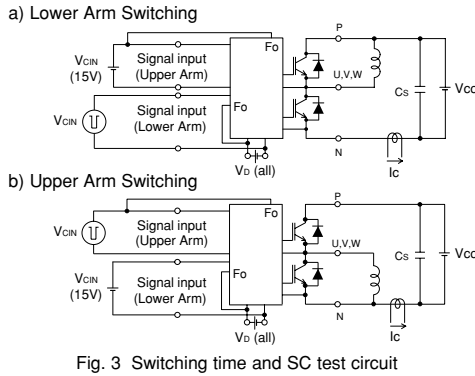
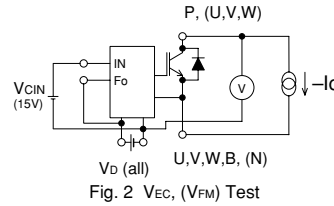
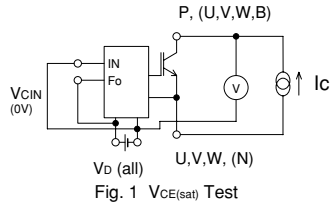

1.5V: Input on threshold voltage  $V_{th(on)}$  typical value, 2V: Input off threshold voltage  $V_{th(off)}$  typical value

Fig. 7 Dead time measurement point example

# PM25RLB120

FLAT-BASE TYPE  
INSULATED PACKAGE

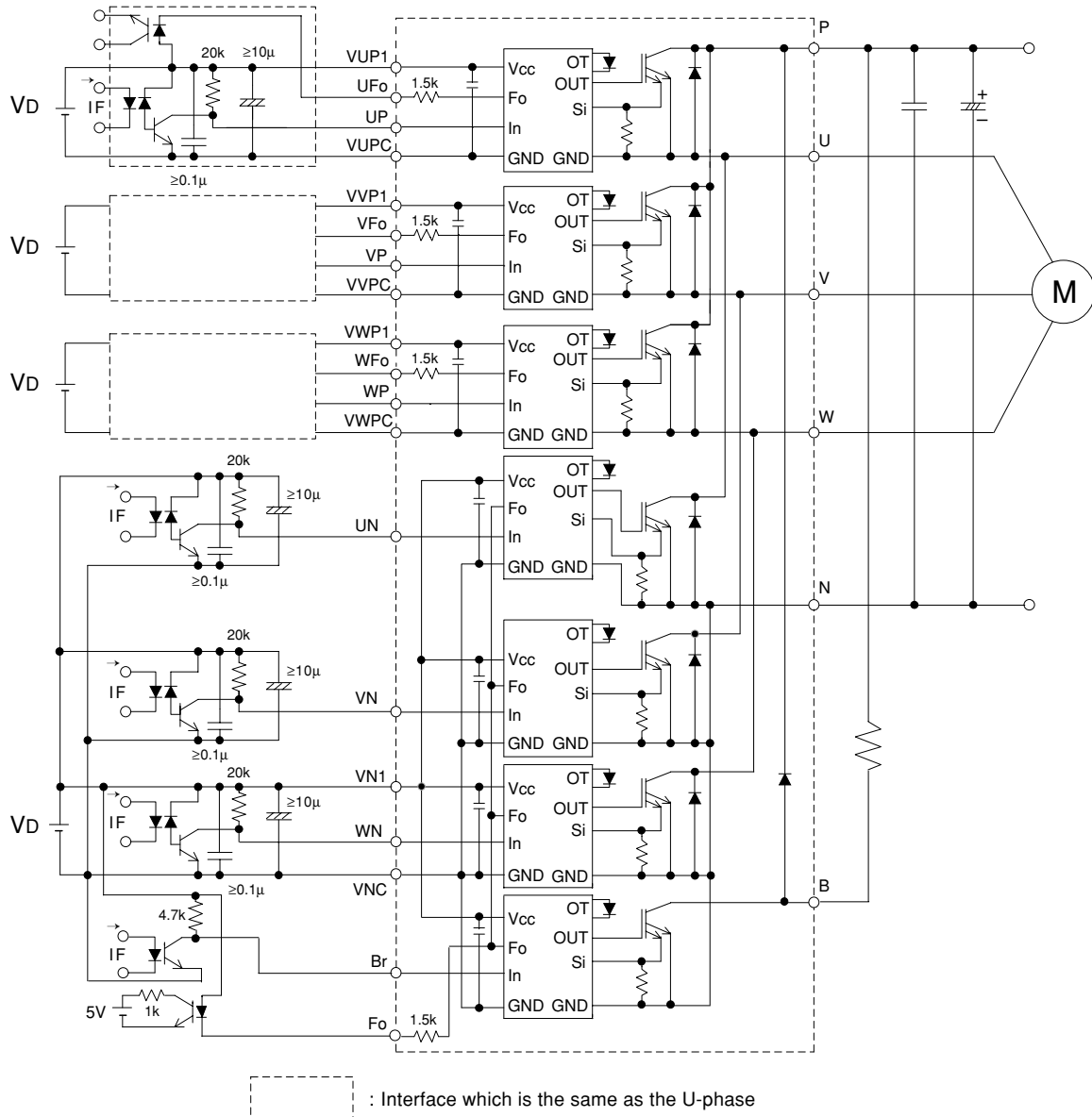

Fig. 8 Application Example Circuit

**NOTES FOR STABLE AND SAFE OPERATION ;**

- Design the PCB pattern to minimize wiring length between opto-coupler and IPM's input terminal, and also to minimize the stray capacity between the input and output wirings of opto-coupler.
- Connect low impedance capacitor between the Vcc and GND terminal of each fast switching opto-coupler.
- Fast switching opto-couplers:  $t_{PLH}, t_{PHL} \leq 0.8\mu s$ , Use High CMR type.
- Slow switching opto-coupler: CTR > 100%
- Use 4 isolated control power supplies (VD). Also, care should be taken to minimize the instantaneous voltage charge of the power supply.
- Make inductance of DC bus line as small as possible, and minimize surge voltage using snubber capacitor between P and N terminal.
- Use line noise filter capacitor (ex. 4.7nF) between each input AC line and ground to reject common-mode noise from AC line and improve noise immunity of the system.

# PM25RLB120

FLAT-BASE TYPE  
INSULATED PACKAGE

## PERFORMANCE CURVES

**OUTPUT CHARACTERISTICS  
(INVERTER PART - TYPICAL)**

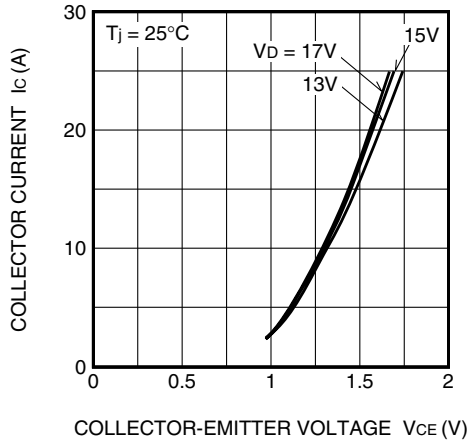

**COLLECTOR-EMITTER SATURATION  
VOLTAGE (VS.  $I_c$ ) CHARACTERISTICS  
(INVERTER PART - TYPICAL)**

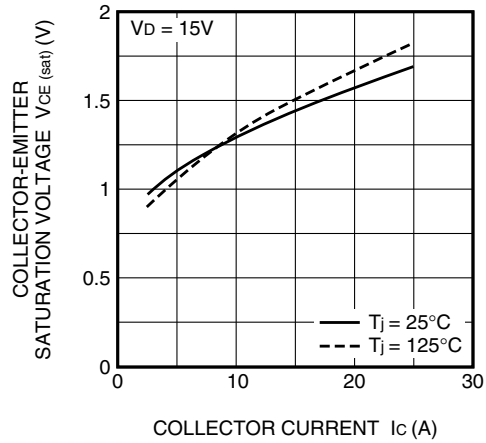

**COLLECTOR-EMITTER SATURATION  
VOLTAGE (VS.  $V_D$ ) CHARACTERISTICS  
(INVERTER PART - TYPICAL)**

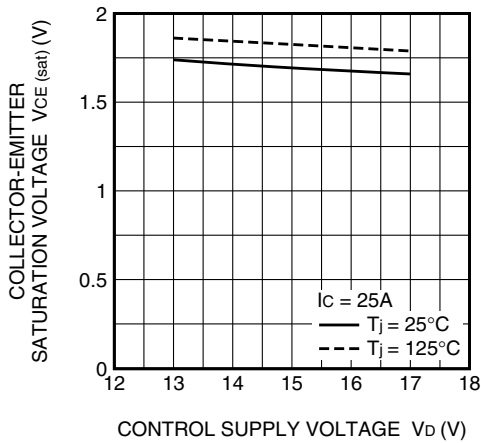

**SWITCHING TIME CHARACTERISTICS  
(TYPICAL)**

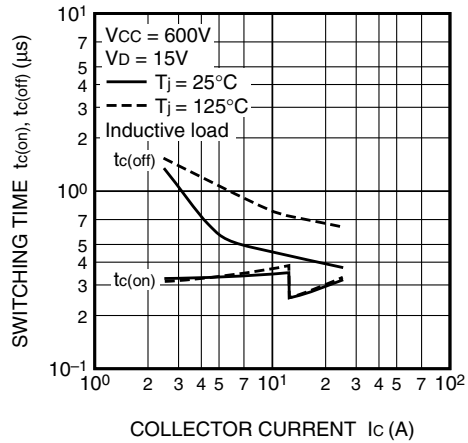

**SWITCHING TIME CHARACTERISTICS  
(TYPICAL)**

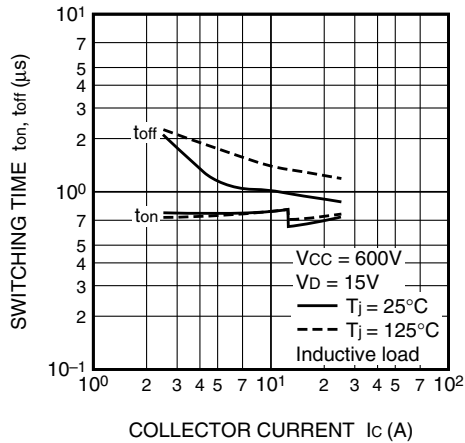

**SWITCHING LOSS CHARACTERISTICS  
(TYPICAL)**

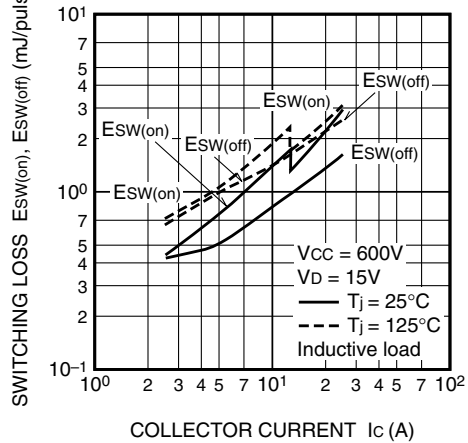

# PM25RLB120

FLAT-BASE TYPE  
INSULATED PACKAGE

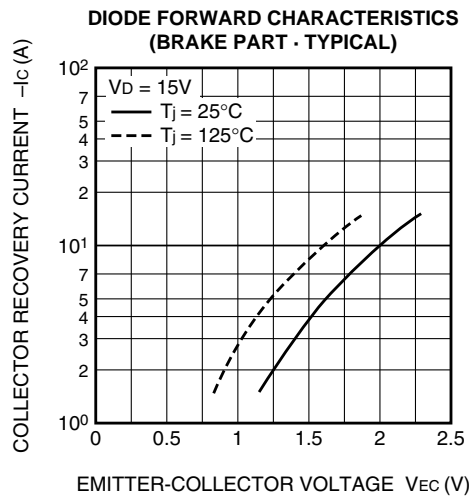
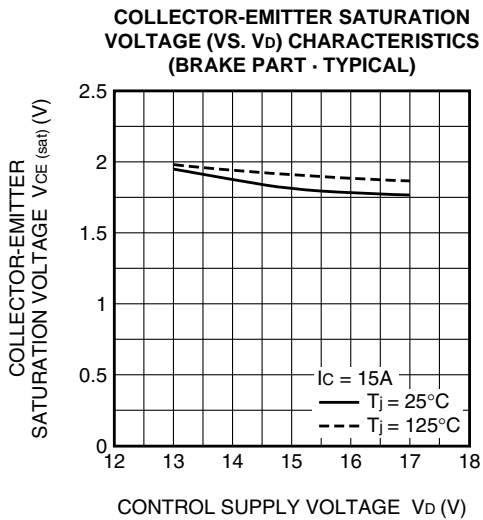
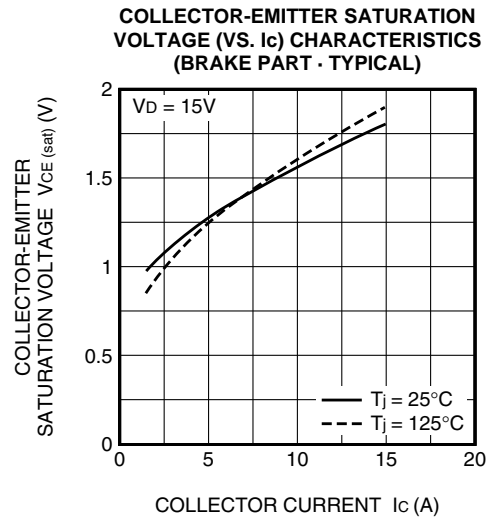
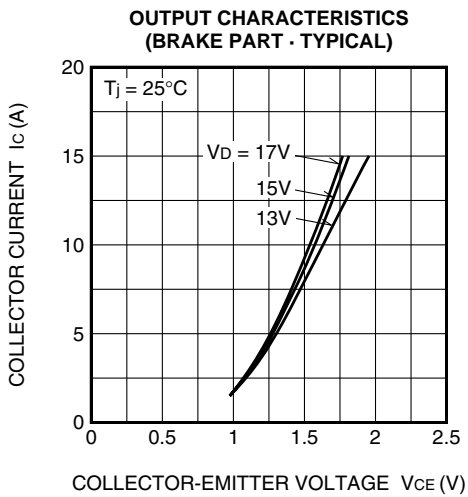
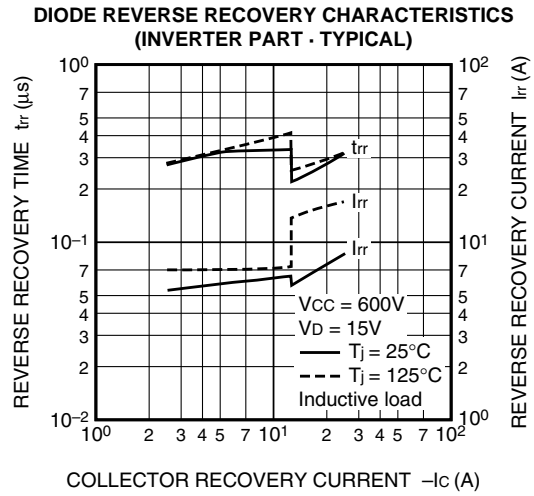
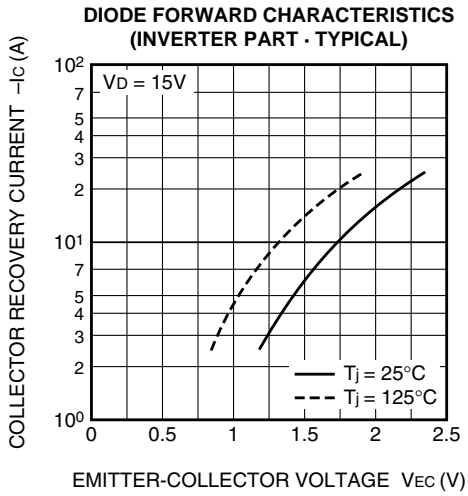



# PM25RLB120

FLAT-BASE TYPE  
INSULATED PACKAGE

**Id VS. fc CHARACTERISTICS  
(TYPICAL)**

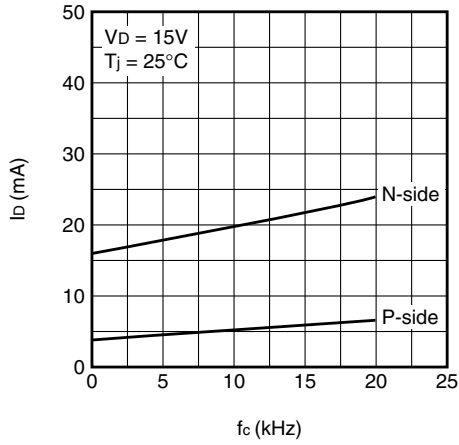

**TRANSIENT THERMAL IMPEDANCE CHARACTERISTICS  
(INVERTER PART)**

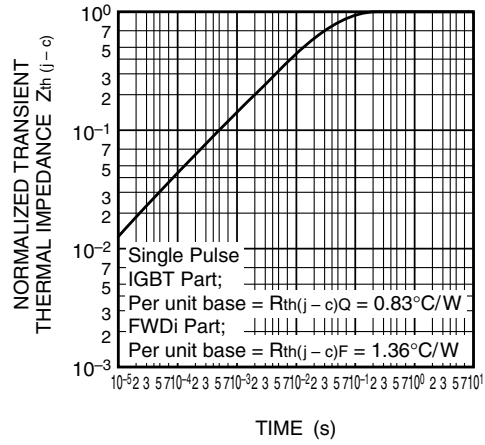

**TRANSIENT THERMAL IMPEDANCE CHARACTERISTICS  
(BRAKE PART)**

