

# NL17SZ17

## Single Non-Inverting Buffer with Schmitt Trigger

The NL17SZ17 is a single Non-inverting Schmitt Trigger Buffer in three tiny footprint packages. The device performs much as LCX multi-gate products in speed and drive.

### Features

- Tiny SOT-353, SOT-553 and SOT-953 Packages
- Source/Sink 24 mA at 3.0 Volts
- Chip Complexity: FETs = 20
- Designed for 1.65 V to 5.5 V  $V_{CC}$  Operation
- NLV Prefix for Automotive and Other Applications Requiring Unique Site and Control Change Requirements; AEC-Q100 Qualified and PPAP Capable
- These Devices are Pb-Free, Halogen Free/BFR Free and are RoHS Compliant

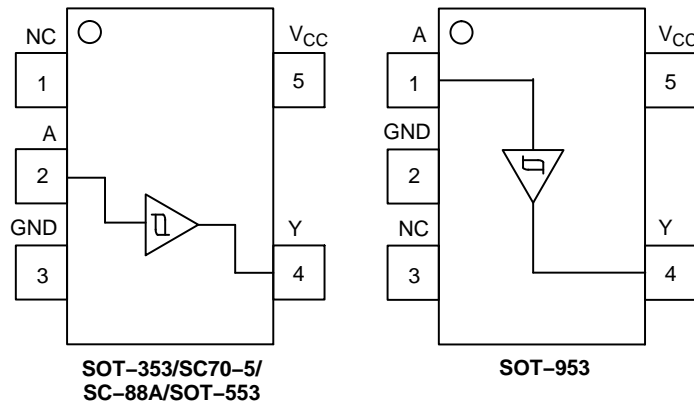


Figure 1. Pinout (Top View)

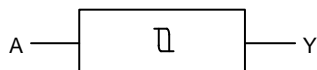


Figure 2. Logic Symbol

### PIN ASSIGNMENT (SOT-353/SC70-5/SC-88A/SOT-553)

Pin	Function
1	NC
2	A
3	GND
4	Y
5	$V_{CC}$

### PIN ASSIGNMENT (SOT-953)

Pin	Function
1	IN A
2	GND
3	NC
4	Y
5	$V_{CC}$

### FUNCTION TABLE

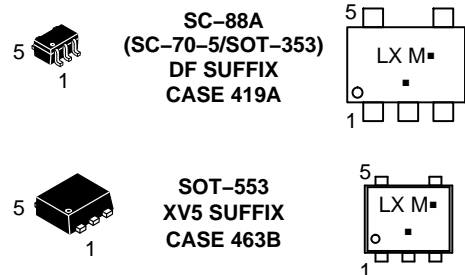
Input	Output
A	Y
L	L
H	H



ON Semiconductor®

[www.onsemi.com](http://www.onsemi.com)

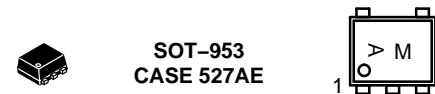
### MARKING DIAGRAMS



LX = Specific Device Code  
M = Date Code\*  
▪ = Pb-Free Package

(Note: Microdot may be in either location)

\*Date Code orientation and/or position may vary depending upon manufacturing location.



A = Specific Device Code  
(A with 90 degree clockwise rotation)  
M = Month Code

### ORDERING INFORMATION

See detailed ordering and shipping information in the package dimensions section on page 5 of this data sheet.

# NL17SZ17

## MAXIMUM RATINGS

Symbol	Parameter	Value	Unit
V <sub>CC</sub>	DC Supply Voltage	-0.5 to +7.0	V
V <sub>I</sub>	DC Input Voltage	-0.5 ≤ V <sub>I</sub> ≤ +7.0	V
V <sub>O</sub>	DC Output Voltage (SOT-353/SC70-5/SC-88A/SOT-553 Packages)	Output in High or LOW State (Note 1) Power-Down Mode	-0.5 to +7.0
V <sub>O</sub>	DC Output Voltage (SOT-953 Package)	-0.5 to V <sub>CC</sub> + 0.5	V
I <sub>IK</sub>	DC Input Diode Current V <sub>I</sub> < GND	-50	mA
I <sub>OK</sub>	DC Output Diode Current (SOT-953 Package)	V <sub>O</sub> < GND, V <sub>O</sub> > V <sub>CC</sub>	±50
I <sub>OK</sub>	DC Output Diode Current (SOT-353/SC70-5/SC-88A/SOT-553 Packages)	V <sub>O</sub> < GND	-50
I <sub>O</sub>	DC Output Sink Current	±50	mA
I <sub>CC</sub>	DC Supply Current per Supply Pin	±100	mA
I <sub>GND</sub>	DC Ground Current per Ground Pin	±100	mA
T <sub>STG</sub>	Storage Temperature Range	-65 to +150	°C
T <sub>L</sub>	Lead Temperature, 1 mm from Case for 10 Seconds	260	°C
T <sub>J</sub>	Junction Temperature under Bias	+150	°C
θ <sub>JA</sub>	Thermal Resistance	SOT-353 (Note 2) SOT-553	350 496
P <sub>D</sub>	Power Dissipation in Still Air at 85°C	SOT-353 SOT-553	186 135
MSL	Moisture Sensitivity	Level 1	
F <sub>R</sub>	Flammability Rating	Oxygen Index: 28 to 34	UL 94 V-0 @ 0.125 in
ESD	ESD Classification	Human Body Model (Note 3) Machine Model (Note 4) Charged Device Model	Class 2 Class C N/A
I <sub>Latchup</sub>	Latchup Performance Above V <sub>CC</sub> and Below GND at 85°C (Note 5)		±500

Stresses exceeding those listed in the Maximum Ratings table may damage the device. If any of these limits are exceeded, device functionality should not be assumed, damage may occur and reliability may be affected.

1. I<sub>O</sub> absolute maximum rating must be observed.
2. Measured with minimum pad spacing on an FR4 board, using 10 mm-by-1 inch, 2-ounce copper trace with no air flow.
3. Tested to EIA/JESD22-A114-A, rated to EIA/JESD22-A114-B.
4. Tested to EIA/JESD22-A115-A, rated to EIA/JESD22-A115-A.
5. Tested to EIA/JESD78.

## RECOMMENDED OPERATING CONDITIONS

Symbol	Parameter	Min	Max	Unit
V <sub>CC</sub>	Supply Voltage	Operating Data Retention Only	1.65 5.5	5.5 V
V <sub>I</sub>	Input Voltage, (Note 6)	0	5.5	V
V <sub>O</sub>	Output Voltage (SOT-353/SC70-5/SC-88A/SOT-553 Packages)	(HIGH or LOW State)	0	5.5
V <sub>O</sub>	Output Voltage (SOT-953 Package)	(HIGH or LOW State)	0	V <sub>CC</sub>
T <sub>A</sub>	Operating Free-Air Temperature	-55	+125	°C
Δt/ΔV	Input Transition Rise or Fall Rate	V <sub>CC</sub> = 2.5 V ±0.2 V V <sub>CC</sub> = 3.0 V ±0.3 V V <sub>CC</sub> = 5.0 V ±0.5 V	0 0 0	No Limit No Limit No Limit

Functional operation above the stresses listed in the Recommended Operating Ranges is not implied. Extended exposure to stresses beyond the Recommended Operating Ranges limits may affect device reliability.

6. Unused inputs may not be left open. All inputs must be tied to a high-logic voltage level or a low-logic input voltage level.

# NL17SZ17

## DC ELECTRICAL CHARACTERISTICS

Symbol	Parameter	Condition	V <sub>CC</sub> (V)	T <sub>A</sub> = 25°C			-55°C ≤ T <sub>A</sub> ≤ 125°C		Units
				Min	Typ	Max	Min	Max	
V <sub>T+</sub>	Positive Input Threshold Voltage		1.65	0.6	1.0	1.4	0.6	1.4	V
			2.3	1.0	1.5	1.8	1.0	1.8	
			2.7	1.2	1.7	2.0	1.2	2.0	
			3.0	1.3	1.9	2.2	1.3	2.2	
			4.5	1.9	2.7	3.1	1.9	3.1	
			5.5	2.2	3.3	3.6	2.2	3.6	
V <sub>T-</sub>	Negative Input Threshold Voltage		1.65	0.2	0.5	0.8	0.2	0.8	V
			2.3	0.4	0.75	1.15	0.4	1.15	
			2.7	0.5	0.87	1.4	0.5	1.4	
			3.0	0.6	1.0	1.5	0.6	1.5	
			4.5	1.0	1.5	2.0	1.0	2.0	
			5.5	1.2	1.9	2.3	1.2	2.3	
V <sub>H</sub>	Input Hysteresis Voltage		1.65	0.1	0.48	0.9	0.1	0.9	V
			2.3	0.25	0.75	1.1	0.25	1.1	
			2.7	0.3	0.83	1.15	0.3	1.15	
			3.0	0.4	0.93	1.2	0.4	1.2	
			4.5	0.6	1.2	1.5	0.6	1.5	
			5.5	0.7	1.4	1.7	0.7	1.7	
V <sub>OH</sub>	High-Level Output Voltage V <sub>IN</sub> = V <sub>IH</sub> or V <sub>IL</sub>	I <sub>OH</sub> = -100 μA I <sub>OH</sub> = -3 mA I <sub>OH</sub> = -8 mA I <sub>OH</sub> = -12 mA I <sub>OH</sub> = -16 mA I <sub>OH</sub> = -24 mA I <sub>OH</sub> = -32 mA	1.65 to 5.5	V <sub>CC</sub> - 0.1	V <sub>CC</sub>		V <sub>CC</sub> - 0.1		V
			1.65	1.29	1.52		1.29		
			2.3	1.9	2.1		1.9		
			2.7	2.2	2.4		2.2		
			3.0	2.4	2.7		2.4		
			3.0	2.3	2.5		2.3		
			4.5	3.8	4.0		3.8		
V <sub>OL</sub>	Low-Level Output Voltage V <sub>IN</sub> = V <sub>IH</sub> or V <sub>IL</sub>	I <sub>OL</sub> = 100 μA I <sub>OL</sub> = 3 mA I <sub>OL</sub> = 8 mA I <sub>OL</sub> = 12 mA I <sub>OL</sub> = 16 mA I <sub>OL</sub> = 24 mA I <sub>OL</sub> = 32 mA	1.65 to 5.5		0.1		0.1	V	
			1.65		0.08	0.24	0.24		
			2.3		0.2	0.3	0.3		
			2.7		0.22	0.4	0.4		
			3.0		0.28	0.4	0.4		
			3.0		0.38	0.55	0.55		
			4.5		0.42	0.55	0.55		
I <sub>IN</sub>	Input Leakage Current	V <sub>IN</sub> = 5.5 V or GND	0 to 5.5		±0.1		±1.0	μA	
I <sub>OFF</sub>	Power Off Leakage Current (SOT-353/ SC70-5/SC-88A/ SOT-553 Packages)	V <sub>IN</sub> = 5.5 V or V <sub>OUT</sub> = 5.5 V	0		1.0		10	μA	
I <sub>CC</sub>	Quiescent Supply Current	V <sub>IN</sub> = 5.5 V or GND	5.5		1.0		10	μA	

## AC ELECTRICAL CHARACTERISTICS (Input t<sub>r</sub> = t<sub>f</sub> = 3.0 ns)

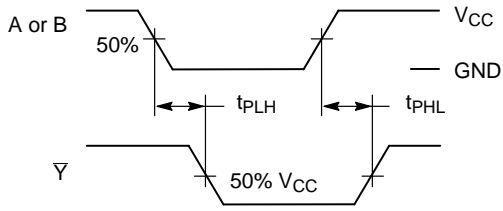
Symbol	Parameter	Condition	V <sub>CC</sub> (V)	T <sub>A</sub> = 25°C			-55°C ≤ T <sub>A</sub> ≤ 125°C		Units
				Min	Typ	Max	Min	Max	
t <sub>PLH</sub> t <sub>PHL</sub>	Propagation Delay Input A to Y (Figures 3 and 4)	R <sub>L</sub> = 1 MΩ, C <sub>L</sub> = 15 pF	1.65	2.0	9.1	15	2.0	15.6	ns
			1.8	2.0	7.6	12.5	2.0	13	
			2.5 ± 0.2	1.0	5.0	9.0	1.0	9.5	
			3.3 ± 0.3	1.0	3.7	6.3	1.0	6.5	
			5.0 ± 0.5	0.5	3.1	5.2	0.5	5.5	
		3.3 ± 0.3	1.5	4.4	7.2	1.5	7.5		
		R <sub>L</sub> = 500 Ω, C <sub>L</sub> = 50 pF	5.0 ± 0.5	0.8	3.7	5.9	0.8	6.2	

## CAPACITIVE CHARACTERISTICS

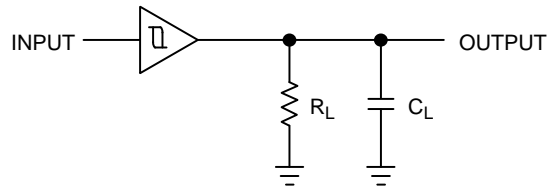
Symbol	Parameter	Condition	Typical	Units
C <sub>IN</sub>	Input Capacitance	V <sub>CC</sub> = 5.5 V, V <sub>I</sub> = 0 V or V <sub>CC</sub>	> 2.5	pF
C <sub>PD</sub>	Power Dissipation Capacitance (Note 7)	10 MHz, V <sub>CC</sub> = 3.3 V, V <sub>I</sub> = 0 V or V <sub>CC</sub>	9	pF
		10 MHz, V <sub>CC</sub> = 5.5 V, V <sub>I</sub> = 0 V or V <sub>CC</sub>	11	

7. C<sub>PD</sub> is defined as the value of the internal equivalent capacitance which is calculated from the operating current consumption without load. Average operating current can be obtained by the equation: I<sub>CC(OPR)</sub> = C<sub>PD</sub> • V<sub>CC</sub> • f<sub>in</sub> + I<sub>CC</sub>. C<sub>PD</sub> is used to determine the no-load dynamic power consumption; P<sub>D</sub> = C<sub>PD</sub> • V<sub>CC</sub><sup>2</sup> • f<sub>in</sub> + I<sub>CC</sub> • V<sub>CC</sub>.

# NL17SZ17

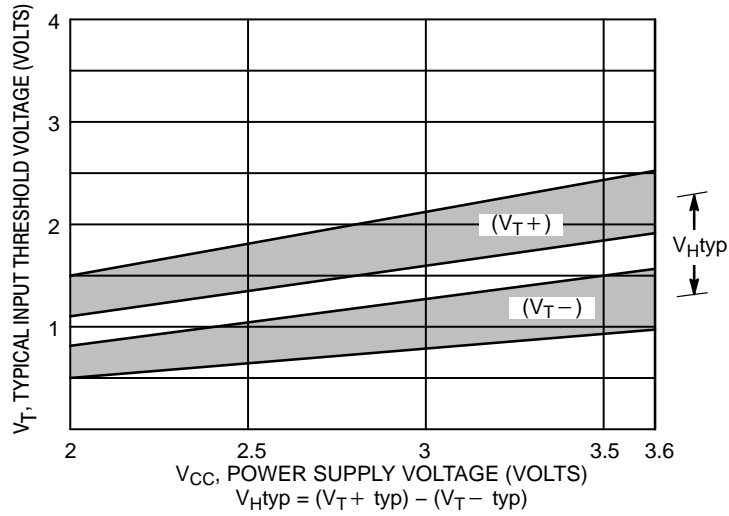


**Figure 3. Switching Waveforms**

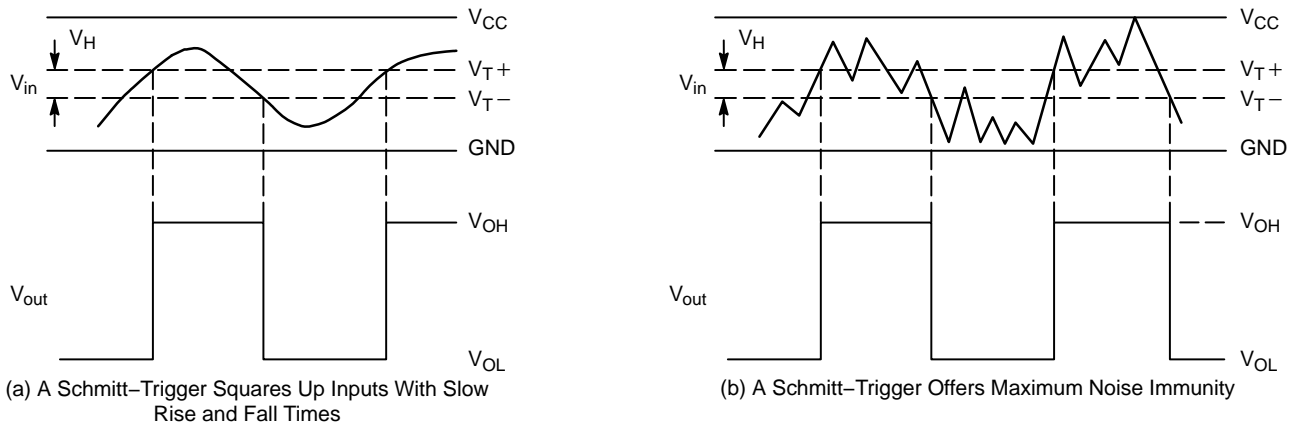


A 1 MHz square input wave is recommended for propagation delay tests.

**Figure 4. Test Circuit**



**Figure 5. Typical Input Threshold,  $V_{T+}$ ,  $V_{T-}$  versus Power Supply Voltage**



**Figure 6. Typical Schmitt-Trigger Applications**

# NL17SZ17

## DEVICE ORDERING INFORMATION

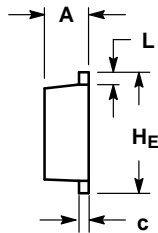
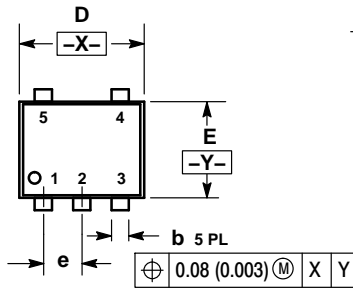
Device Order Number	Package Type	Tape/Reel Size†
NL17SZ17DFT2G	SC-88A/SC-70-5/SOT-353 (Pb-Free)	3000 Units / Tape & Reel
NLV17SZ17DFT2G*	SC-88A/SC-70-5/SOT-353 (Pb-Free)	3000 Units / Tape & Reel
NL17SZ17XV5T2G	SOT-553 (Pb-Free)	4000 Units / Tape & Reel
NL17SZ17XV5T2GH	SOT-553 (Pb-Free)	4000 Units / Tape & Reel
NL17SZ17P5T5G	SOT-953 (Pb-Free)	8000 Units / Tape & Reel

†For information on tape and reel specifications, including part orientation and tape sizes, please refer to our Tape and Reel Packaging Specifications Brochure, BRD8011/D.

\*NLV Prefix for Automotive and Other Applications Requiring Unique Site and Control Change Requirements; AEC-Q100 Qualified and PPAP Capable.

## PACKAGE DIMENSIONS

### SOT-553 XV5 SUFFIX CASE 463B ISSUE B

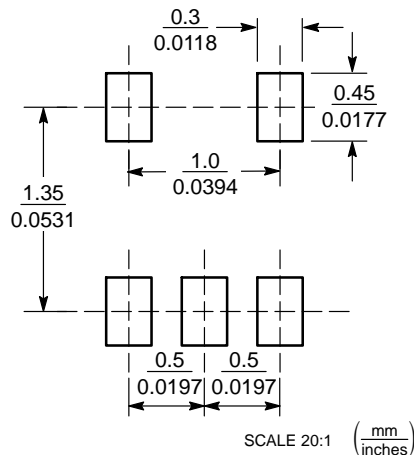


#### NOTES:

1. DIMENSIONING AND TOLERANCING PER ANSI Y14.5M, 1982.
2. CONTROLLING DIMENSION: MILLIMETERS
3. MAXIMUM LEAD THICKNESS INCLUDES LEAD FINISH THICKNESS. MINIMUM LEAD THICKNESS IS THE MINIMUM THICKNESS OF BASE MATERIAL.

DIM	MILLIMETERS			INCHES		
	MIN	NOM	MAX	MIN	NOM	MAX
A	0.50	0.55	0.60	0.020	0.022	0.024
b	0.17	0.22	0.27	0.007	0.009	0.011
c	0.08	0.13	0.18	0.003	0.005	0.007
D	1.50	1.60	1.70	0.059	0.063	0.067
E	1.10	1.20	1.30	0.043	0.047	0.051
e	0.50 BSC			0.020 BSC		
L	0.10	0.20	0.30	0.004	0.008	0.012
HE	1.50	1.60	1.70	0.059	0.063	0.067

## SOLDERING FOOTPRINT\*

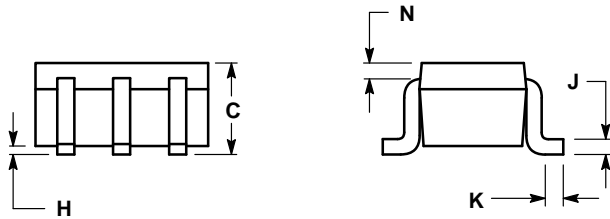
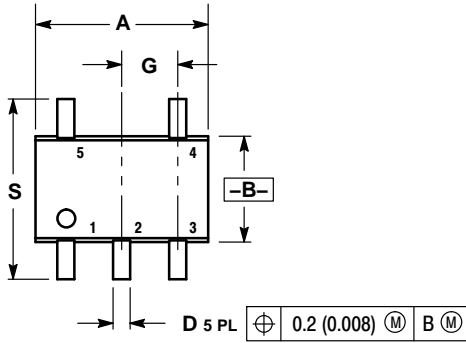


\*For additional information on our Pb-Free strategy and soldering details, please download the ON Semiconductor Soldering and Mounting Techniques Reference Manual, SOLDERRM/D.

# NL17SZ17

## PACKAGE DIMENSIONS

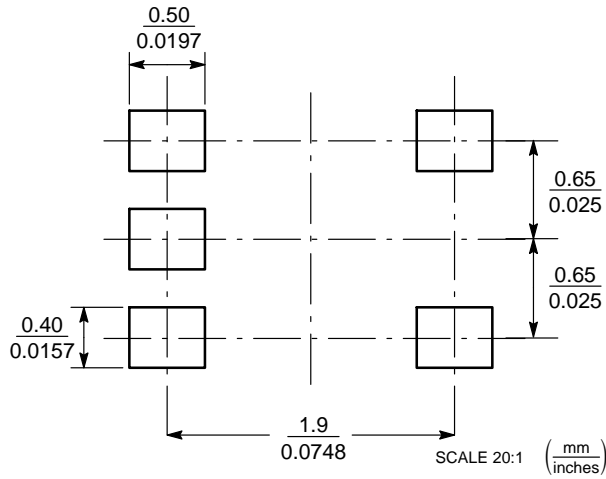
**SC-88A (SC-70-5/SOT-353)**  
CASE 419A-02  
ISSUE L



- NOTES:
1. DIMENSIONING AND TOLERANCING PER ANSI Y14.5M, 1982.
  2. CONTROLLING DIMENSION: INCH.
  3. 419A-01 OBSOLETE. NEW STANDARD 419A-02.
  4. DIMENSIONS A AND B DO NOT INCLUDE MOLD FLASH, PROTRUSIONS, OR GATE BURRS.

DIM	INCHES		MILLIMETERS	
	MIN	MAX	MIN	MAX
A	0.071	0.087	1.80	2.20
B	0.045	0.053	1.15	1.35
C	0.031	0.043	0.80	1.10
D	0.004	0.012	0.10	0.30
G	0.026 BSC		0.65 BSC	
H	---	0.004	---	0.10
J	0.004	0.010	0.10	0.25
K	0.004	0.012	0.10	0.30
N	0.008 REF		0.20 REF	
S	0.079	0.087	2.00	2.20

### SOLDERING FOOTPRINT\*

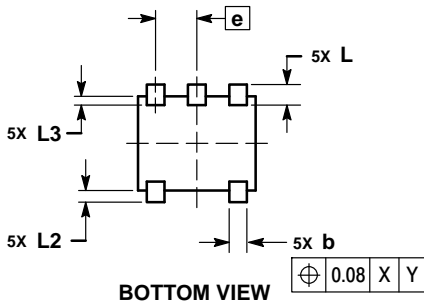
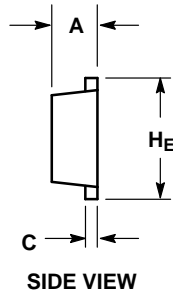
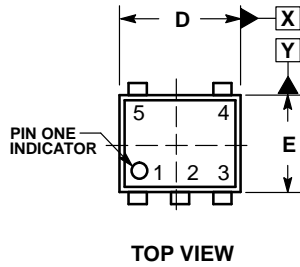


\*For additional information on our Pb-Free strategy and soldering details, please download the ON Semiconductor Soldering and Mounting Techniques Reference Manual, SOLDERRM/D.

# NL17SZ17

## PACKAGE DIMENSIONS

### SOT-953 CASE 527AE ISSUE E

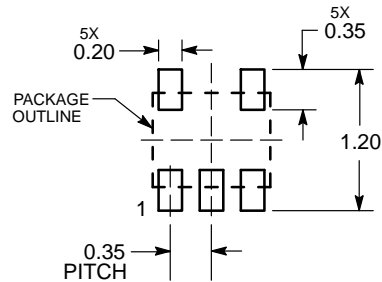


**NOTES:**

1. DIMENSIONING AND TOLERANCING PER ASME Y14.5M, 1994.
2. CONTROLLING DIMENSION: MILLIMETERS
3. MAXIMUM LEAD THICKNESS INCLUDES LEAD FINISH. MINIMUM LEAD THICKNESS IS THE MINIMUM THICKNESS OF THE BASE MATERIAL.
4. DIMENSIONS D AND E DO NOT INCLUDE MOLD FLASH, PROTRUSIONS, OR GATE BURRS.


MILLIMETERS			
DIM	MIN	NOM	MAX
A	0.34	0.37	0.40
b	0.10	0.15	0.20
C	0.07	0.12	0.17
D	0.95	1.00	1.05
E	0.75	0.80	0.85
e	0.35 BSC		
He	0.95	1.00	1.05
L	0.175 REF		
L2	0.05	0.10	0.15
L3	---	---	0.15

### SOLDERING FOOTPRINT\*



DIMENSIONS: MILLIMETERS

\*For additional information on our Pb-Free strategy and soldering details, please download the ON Semiconductor Soldering and Mounting Techniques Reference Manual, SOLDERRM/D.

ON Semiconductor and the  are registered trademarks of Semiconductor Components Industries, LLC (SCILLC) or its subsidiaries in the United States and/or other countries. SCILLC owns the rights to a number of patents, trademarks, copyrights, trade secrets, and other intellectual property. A listing of SCILLC's product/patent coverage may be accessed at [www.onsemi.com/site/pdf/Patent-Marketing.pdf](http://www.onsemi.com/site/pdf/Patent-Marketing.pdf). SCILLC reserves the right to make changes without further notice to any products herein. SCILLC makes no warranty, representation or guarantee regarding the suitability of its products for any particular purpose, nor does SCILLC assume any liability arising out of the application or use of any product or circuit, and specifically disclaims any and all liability, including without limitation special, consequential or incidental damages. "Typical" parameters which may be provided in SCILLC data sheets and/or specifications can and do vary in different applications and actual performance may vary over time. All operating parameters, including "Typicals" must be validated for each customer application by customer's technical experts. SCILLC does not convey any license under its patent rights nor the rights of others. SCILLC products are not designed, intended, or authorized for use as components in systems intended for surgical implant into the body, or other applications intended to support or sustain life, or for any other application in which the failure of the SCILLC product could create a situation where personal injury or death may occur. Should Buyer purchase or use SCILLC products for any such unintended or unauthorized application, Buyer shall indemnify and hold SCILLC and its officers, employees, subsidiaries, affiliates, and distributors harmless against all claims, costs, damages, and expenses, and reasonable attorney fees arising out of, directly or indirectly, any claim of personal injury or death associated with such unintended or unauthorized use, even if such claim alleges that SCILLC was negligent regarding the design or manufacture of the part. SCILLC is an Equal Opportunity/Affirmative Action Employer. This literature is subject to all applicable copyright laws and is not for resale in any manner.

### PUBLICATION ORDERING INFORMATION

**LITERATURE FULFILLMENT:**  
Literature Distribution Center for ON Semiconductor  
19521 E. 32nd Pkwy, Aurora, Colorado 80011 USA  
**Phone:** 303-675-2175 or 800-344-3860 Toll Free USA/Canada  
**Fax:** 303-675-2176 or 800-344-3867 Toll Free USA/Canada  
**Email:** [orderlit@onsemi.com](mailto:orderlit@onsemi.com)

**N. American Technical Support:** 800-282-9855 Toll Free  
USA/Canada  
**Europe, Middle East and Africa Technical Support:**  
Phone: 421 33 790 2910  
**Japan Customer Focus Center**  
Phone: 81-3-5817-1050

**ON Semiconductor Website:** [www.onsemi.com](http://www.onsemi.com)  
**Order Literature:** <http://www.onsemi.com/orderlit>

For additional information, please contact your local Sales Representative