



SL869-ADR Product User Guide

1VV0301308 r2

2017-04-07

TELIT
TECHNICAL
DOCUMENTATION

SPECIFICATIONS ARE SUBJECT TO CHANGE WITHOUT NOTICE

NOTICE

While reasonable efforts have been made to assure the accuracy of this document, Telit assumes no liability resulting from any inaccuracies or omissions in this document, or from use of the information obtained herein. The information in this document has been carefully checked and is believed to be reliable. However, no responsibility is assumed for inaccuracies or omissions. Telit reserves the right to make changes to any products described herein and reserves the right to revise this document and to make changes from time to time in content hereof with no obligation to notify any person of revisions or changes. Telit does not assume any liability arising out of the application or use of any product, software, or circuit described herein; neither does it convey license under its patent rights or the rights of others.

It is possible that this publication may contain references to, or information about Telit products (machines and programs), programming, or services that are not announced in your country. Such references or information must not be construed to mean that Telit intends to announce such Telit products, programming, or services in your country.

COPYRIGHTS

This instruction manual and the Telit products described in this instruction manual may be, include or describe copyrighted Telit material, such as computer programs stored in semiconductor memories or other media. Laws in the Italy and other countries preserve for Telit and its licensors certain exclusive rights for copyrighted material, including the exclusive right to copy, reproduce in any form, distribute and make derivative works of the copyrighted material. Accordingly, any copyrighted material of Telit and its licensors contained herein or in the Telit products described in this instruction manual may not be copied, reproduced, distributed, merged or modified in any manner without the express written permission of Telit. Furthermore, the purchase of Telit products shall not be deemed to grant either directly or by implication, estoppel, or otherwise, any license under the copyrights, patents or patent applications of Telit, as arises by operation of law in the sale of a product.

COMPUTER SOFTWARE COPYRIGHTS

The Telit and 3rd Party supplied Software (SW) products described in this instruction manual may include copyrighted Telit and other 3rd Party supplied computer programs stored in semiconductor memories or other media. Laws in the Italy and other countries preserve for Telit and other 3rd Party supplied SW certain exclusive rights for copyrighted computer programs, including the exclusive right to copy or reproduce in any form the copyrighted computer program. Accordingly, any copyrighted Telit or other 3rd Party supplied SW computer programs contained in the Telit products described in this instruction manual may not be copied (reverse engineered) or reproduced in any manner without the express written permission of Telit or the 3rd Party SW supplier. Furthermore, the purchase of Telit products shall not be deemed to grant either directly or by implication, estoppel, or otherwise, any license under the copyrights, patents or patent applications of Telit or other 3rd Party supplied SW, except for the normal non-exclusive, royalty free license to use that arises by operation of law in the sale of a product.

USAGE AND DISCLOSURE RESTRICTIONS

I. License Agreements

The software described in this document is the property of Telit and its licensors. It is furnished by express license agreement only and may be used only in accordance with the terms of such an agreement.

II. Copyrighted Materials

Software and documentation are copyrighted materials. Making unauthorized copies is prohibited by law. No part of the software or documentation may be reproduced, transmitted, transcribed, stored in a retrieval system, or translated into any language or computer language, in any form or by any means, without prior written permission of Telit

III. High Risk Materials

Components, units, or third-party products used in the product described herein are NOT fault-tolerant and are NOT designed, manufactured, or intended for use as on-line control equipment in the following hazardous environments requiring fail-safe controls: the operation of Nuclear Facilities, Aircraft Navigation or Aircraft Communication Systems, Air Traffic Control, Life Support, or Weapons Systems (High Risk Activities"). Telit and its supplier(s) specifically disclaim any expressed or implied warranty of fitness for such High Risk Activities.

IV. Trademarks

TELIT and the Stylized T Logo are registered in Trademark Office. All other product or service names are the property of their respective owners.

V. Third Party Rights

The software may include Third Party Right software. In this case, you agree to comply with all terms and conditions imposed on you in respect of such separate software. In addition to Third Party Terms, the disclaimer of warranty and limitation of liability provisions in this License shall apply to the Third Party Right software.

TELIT HEREBY DISCLAIMS ANY AND ALL WARRANTIES EXPRESS OR IMPLIED FROM ANY THIRD PARTIES REGARDING ANY SEPARATE FILES, ANY THIRD PARTY MATERIALS INCLUDED IN THE SOFTWARE, ANY THIRD PARTY MATERIALS FROM WHICH THE SOFTWARE IS DERIVED (COLLECTIVELY "OTHER CODE"), AND THE USE OF ANY OR ALL THE OTHER CODE IN CONNECTION WITH THE SOFTWARE, INCLUDING (WITHOUT LIMITATION) ANY WARRANTIES OF SATISFACTORY QUALITY OR FITNESS FOR A PARTICULAR PURPOSE.

NO THIRD PARTY LICENSORS OF OTHER CODE SHALL HAVE ANY LIABILITY FOR ANY DIRECT, INDIRECT, INCIDENTAL, SPECIAL, EXEMPLARY, OR CONSEQUENTIAL DAMAGES (INCLUDING WITHOUT LIMITATION LOST PROFITS), HOWEVER CAUSED AND WHETHER MADE UNDER CONTRACT, TORT OR OTHER LEGAL THEORY, ARISING IN ANY WAY OUT OF THE USE OR DISTRIBUTION OF THE OTHER CODE OR THE EXERCISE OF ANY RIGHTS GRANTED UNDER EITHER OR BOTH THIS LICENSE AND THE LEGAL TERMS APPLICABLE TO ANY SEPARATE FILES, EVEN IF ADVISED OF THE POSSIBILITY OF SUCH DAMAGES.

PRODUCT APPLICABILITY TABLE

Product
SL869-ADR

CONTENTS

NOTICE	2
COPYRIGHTS	2
COMPUTER SOFTWARE COPYRIGHTS	2
USAGE AND DISCLOSURE RESTRICTIONS	3
PRODUCT APPLICABILITY TABLE	4
1. INTRODUCTION	11
1.1. Purpose	11
1.2. Contact and Support Information	11
1.3. Text Conventions	12
1.4. Related Documents	12
1.5. Related Products	12
2. PRODUCT DESCRIPTION	13
2.1. Product Overview	13
2.2. Block Diagram	14
2.3. Module Photo	15
3. EVALUATION KIT (EVK)	16
4. DEAD RECKONING OVERVIEW	17
4.1. SL869-ADR Operation	17
4.2. Example of the DR Function	17
5. PRODUCT FEATURES	18
5.1. Multi-Constellation Navigation	18
5.2. Quasi-Zenith Satellite System (QZSS) support	18
5.3. Satellite Based Augmentation System (SBAS)	18
5.3.1. SBAS Corrections	18
5.3.2. SBAS Ranging	18
5.4. Assisted GPS (AGPS)	18
5.4.1. Locally-generated AGPS (ST-AGPS)	19
5.4.2. Server-generated AGPS (PGPS/PGLO)	19
5.5. Differential GPS (DGPS)	19
5.6. Static Navigation	19
5.7. Elevation Mask Angle	19
5.8. Internal LNA	19
5.9. 1PPS	19

5.10.	Antenna Enable	20
5.11.	Antenna Sense	20
5.12.	Serial I/O Ports	20
5.12.1.	UART	20
5.12.2.	I ² C.....	20
6.	MODULE ORIENTATION, MOUNTING, AND CALIBRATION...	21
6.1.	Module Orientation	21
6.2.	Module Mounting	22
6.3.	Module Calibration.....	22
7.	SOFTWARE INTERFACE	23
7.1.	NMEA Output Messages	23
7.1.1.	NMEA Standard Messages.....	23
7.1.2.	NMEA Talker IDs	24
7.2.	Proprietary Messages	24
7.3.	NMEA Input Commands	24
8.	PRODUCT PERFORMANCE	25
8.1.	Horizontal Position Accuracy	25
8.2.	Time to First Fix	25
8.3.	Sensitivity	26
9.	FLASH UPGRADABILITY.....	27
10.	ELECTRICAL INTERFACE.....	28
10.1.	Pin-out Diagram and Table	28
10.2.	DC Characteristics.....	30
10.3.	Absolute Maximum Ratings	30
10.4.	Power Supply.....	31
10.4.1.	VCC.....	31
10.4.2.	VBATT	31
10.4.3.	DC Power Requirements	32
10.4.4.	DC Power Consumption	32
10.5.	RF interface	33
10.5.1.	RF IN	33
10.5.2.	External Active Antenna Voltage.....	33
10.5.3.	Burnout Protection	33
10.5.4.	Frequency Plan.....	33
10.5.5.	Local Oscillator Leakage.....	34
10.6.	Antenna Interface	34
10.6.1.	Antenna Enable	34
10.6.2.	Antenna Sense	34
10.7.	Control and Status signals	34

10.7.1.	Startup Requirements	34
10.7.2.	nRESET.....	34
10.7.3.	Boot Select	34
10.7.4.	1PPS	35
10.8.	Vehicle Sensor Signals	35
10.8.1.	Forward / Reverse	35
10.8.2.	Wheel Tick.....	35
10.9.	I/O Port Operation.....	35
10.9.1.	UART Port Operation.....	35
10.9.2.	I ² C Port Operation.....	35
11.	REFERENCE DESIGN	36
11.1.	SL869-ADR Reference Design	36
12.	RF FRONT END DESIGN.....	38
12.1.	RF Signal Requirements.....	38
12.2.	GNSS Antenna Polarization.....	39
12.3.	Active versus Passive Antenna	40
12.4.	GNSS Antenna Gain.....	40
12.5.	RF Trace Losses	41
12.6.	PCB stack and Trace Impedance.....	41
12.7.	Powering an External LNA (active antenna).....	41
12.8.	RF Interference.....	42
12.9.	Shielding.....	42
13.	MECHANICAL DRAWING	43
14.	PCB FOOTPRINT	45
15.	PRODUCT PACKAGING AND HANDLING	46
15.1.	Product Marking and Serialization.....	46
15.2.	Product Packaging.....	47
15.3.	Moisture Sensitivity	48
15.4.	ESD Sensitivity	50
15.5.	Reflow.....	50
15.6.	Assembly Considerations.....	50
15.7.	Washing Considerations	50
15.8.	Safety	51
15.9.	Disposal.....	51
16.	ENVIRONMENTAL REQUIREMENTS	52
16.1.	Operating Environmental Limits	52
16.2.	Storage Environmental Limits	52

17. COMPLIANCES 53

18. GLOSSARY AND ACRONYMS 54

19. SAFETY RECOMMENDATIONS..... 57

19.1. READ CAREFULLY 57

19.2. Electrical and Fire Safety 58

20. DOCUMENT HISTORY 59

FIGURES

Figure 2-1 SL869-ADR Block Diagram.....	14
Figure 2-2 SL869-ADR Module Photo.....	15
Figure 3-1 Evaluation Kit (EVK) contents	16
Figure 6-1 Module Orientation.....	21
Figure 6-2 Module Vertical axis.....	21
Figure 10-1 SL869-ADR Pin-out Diagram	28
Figure 11-1 SL869-ADR Reference Design	36
Figure 12-1 RF Trace Examples	41
Figure 13-1 SL869-ADR Mechanical Drawing.....	43
Figure 13-2 3-D Mechanical Drawing	44
Figure 14-1 SL869-ADR PCB Footprint	45
Figure 15-1 Product Label.....	46
Figure 15-2 Tape and Reel Packaging.....	47
Figure 15-3 Tape and Reel – Tape detail.....	47
Figure 15-4 Tray Packaging.....	48
Figure 15-5 Moisture-Sensitive Device Label	49

TABLES

Table 7-1 Default NMEA Output Messages.....	23
Table 7-2 Available Messages	23
Table 7-3 NMEA Talker IDs	24
Table 8-1 SL869-ADR Horizontal Position Accuracy.....	25
Table 8-2 SL869-ADR Time To First Fix	25
Table 8-3 SL869-ADR Sensitivity.....	26
Table 10-1 SL869-ADR Pin-out Table.....	29
Table 10-2 DC Characteristics	30
Table 10-3 Absolute Maximum Ratings.....	30
Table 10-4 DC Supply Voltage.....	32
Table 10-5 Power Consumption.....	32
Table 10-6 Frequency Plan.....	33
Table 10-7 LO Leakage	34
Table 12-1 Inductor Loss	42
Table 16-1 Operating Environmental Limits	52
Table 16-2 Storage Environmental Limits.....	52

1. INTRODUCTION

1.1. Purpose

The purpose of this document is to provide product information for the SL869-ADR GNSS module.

1.2. Contact and Support Information

For general contact, technical support services, technical questions and report documentation errors contact Telit Technical Support at:

- TS-EMEA@telit.com
- TS-AMERICAS@telit.com
- TS-APAC@telit.com

Alternatively, use:

<http://www.telit.com/support>

For detailed information about where you can buy the Telit modules or for recommendations on accessories and components visit:

<http://www.telit.com>



For GNSS product information visit:

<http://www.telit.com/gnss/>

Our aim is to make this guide as helpful as possible. Keep us informed of your comments and suggestions for improvements.

Telit appreciates feedback from the users of our information.

1.3. Text Conventions

Symbol	Description
	Danger – This information MUST be followed or catastrophic equipment failure and/or bodily injury may occur.
	Caution or Warning – This is an important point about integrating the product into a system. If this information is disregarded, the product or system may malfunction or fail.
	Tip – This is advice or suggestion that may be useful when integrating the product.

- Dates are in ISO 8601 format, i.e. YYYY-MM-DD.

1.4. Related Documents

- SL869-ADR Data Sheet
- SL869-ADR Evaluation Kit User Guide
- V33 Software User Guide

A Non-Disclosure Agreement is required for the following documents:

- Antenna Sense Application Note
- V33 Software Authorized User Guide
- SV33 CLDR Software User Guide

1.5. Related Products

- SL869-V3: The SL869-V3 module omits the MEMS devices and DR firmware.
See <http://www.telit.com/gnss/>

2. PRODUCT DESCRIPTION

The SL869-ADR module is based on the SL869-V3 GNSS receiver with the addition of specialized hardware and software. It includes an ST Micro Teseo III GNSS receiver with an ARM-9 processor, flash memory, TCXO, RTC crystal, LNA and SAW filter plus embedded MEMS sensors (6-axis accelerometers+gyros).

The software includes features to receive and use data from the built-in sensors along with external signals for wheel speed and Forward/Reverse direction. The vehicle signals are used to provide a high level of accuracy in the navigation solution.

2.1. Product Overview

- Complete GNSS receiver module including memory, TCXO, SAW filter, LNA, RTC crystal and DC blocking capacitor
- Firmware to combine data from embedded sensors and external signals with GNSS measurements to develop a navigation solution.
- Wheel ticks and Forward/Reverse signals provide high-accuracy positioning
- Constellations:
 - GPS, GLONASS, BeiDou, and QZSS. Galileo ready.
 - SBAS: WAAS, EGNOS, MSAS, GAGAN
- AGPS: Assisted GNSS (local and server-based)
- Differential GPS (DGPS) capable using the RTCM SC-104 protocol
- NMEA-0183 command input and data output
- ST Teseo III GNSS receiver chip
 - ARM946 MCU (up to 196 MHz)
 - 16 Mbit SQI Flash memory
 - 256 Kbyte embedded SRAM
 - 48 tracking channels + 2 fast acquisition channels
 - Real Time Clock
- MEMS sensors: 3-axis gyro and 3-axis accelerometer
- RF front end LNA
- SAW filter
- RTC crystal
- TCXO
- 2 UART ports
- I²C master/slave port (dedicated to MEMS sensor I/O)
- Antenna on (output)
- Antenna sense (input)
- -162 dBm tracking sensitivity
- -40°C to +85°C temperature range

2.2. Block Diagram

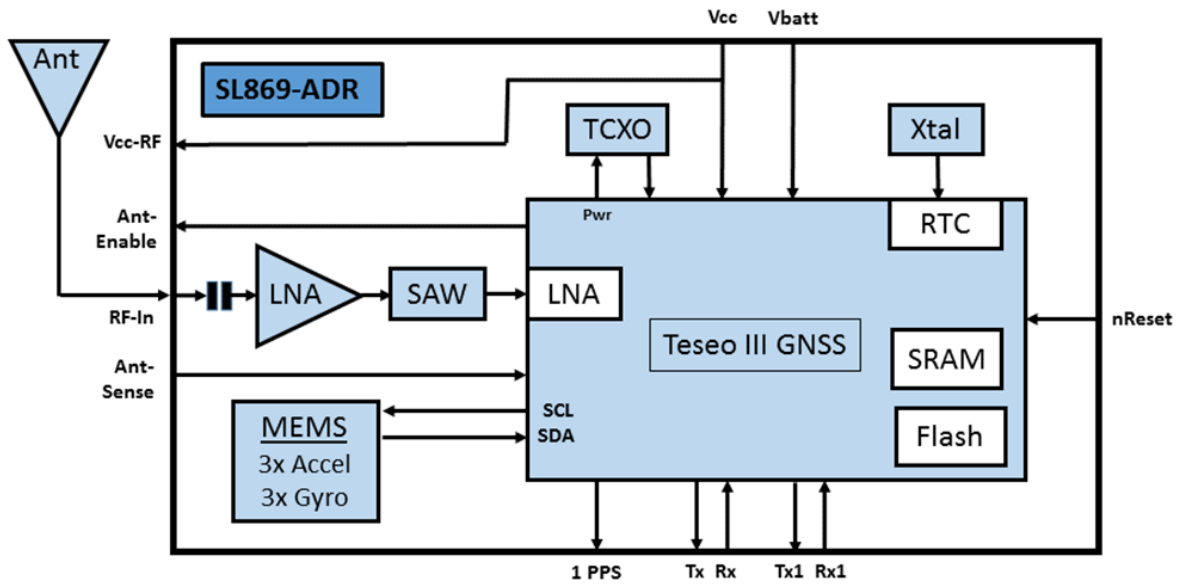

Figure 2-1 SL869-ADR Block Diagram

2.3. Module Photo

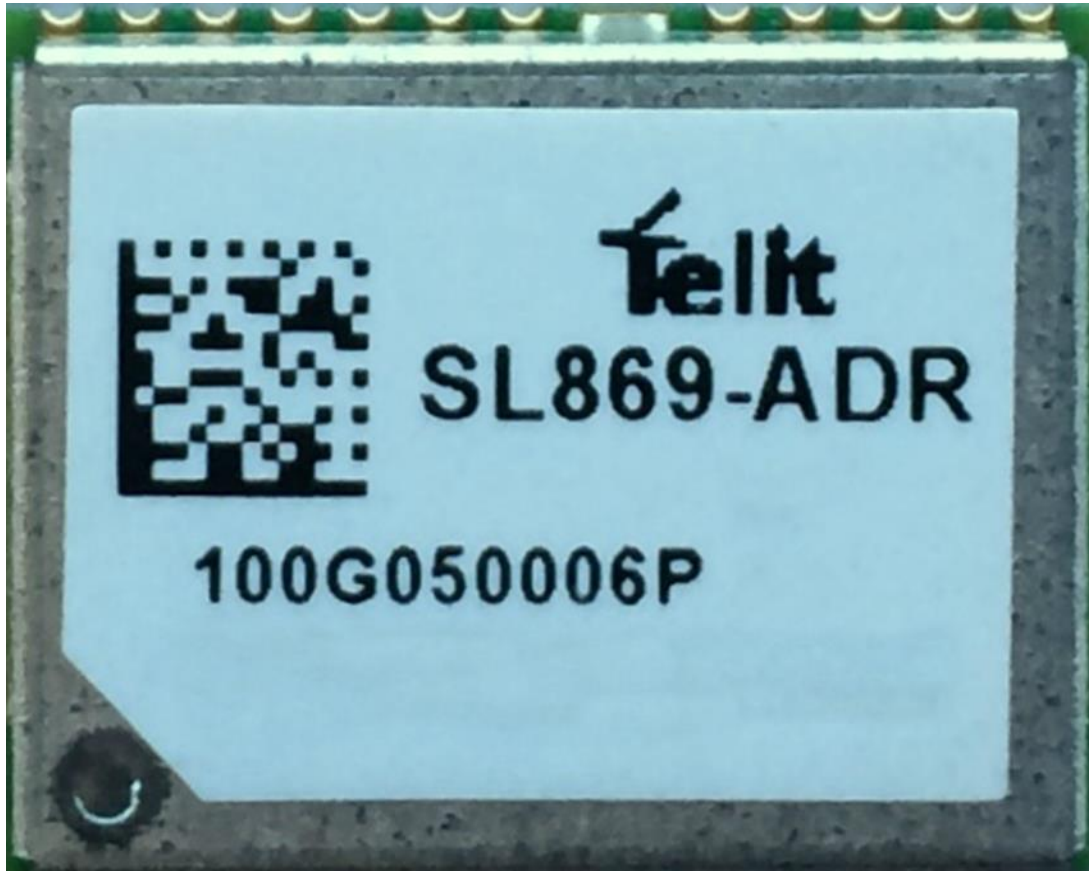
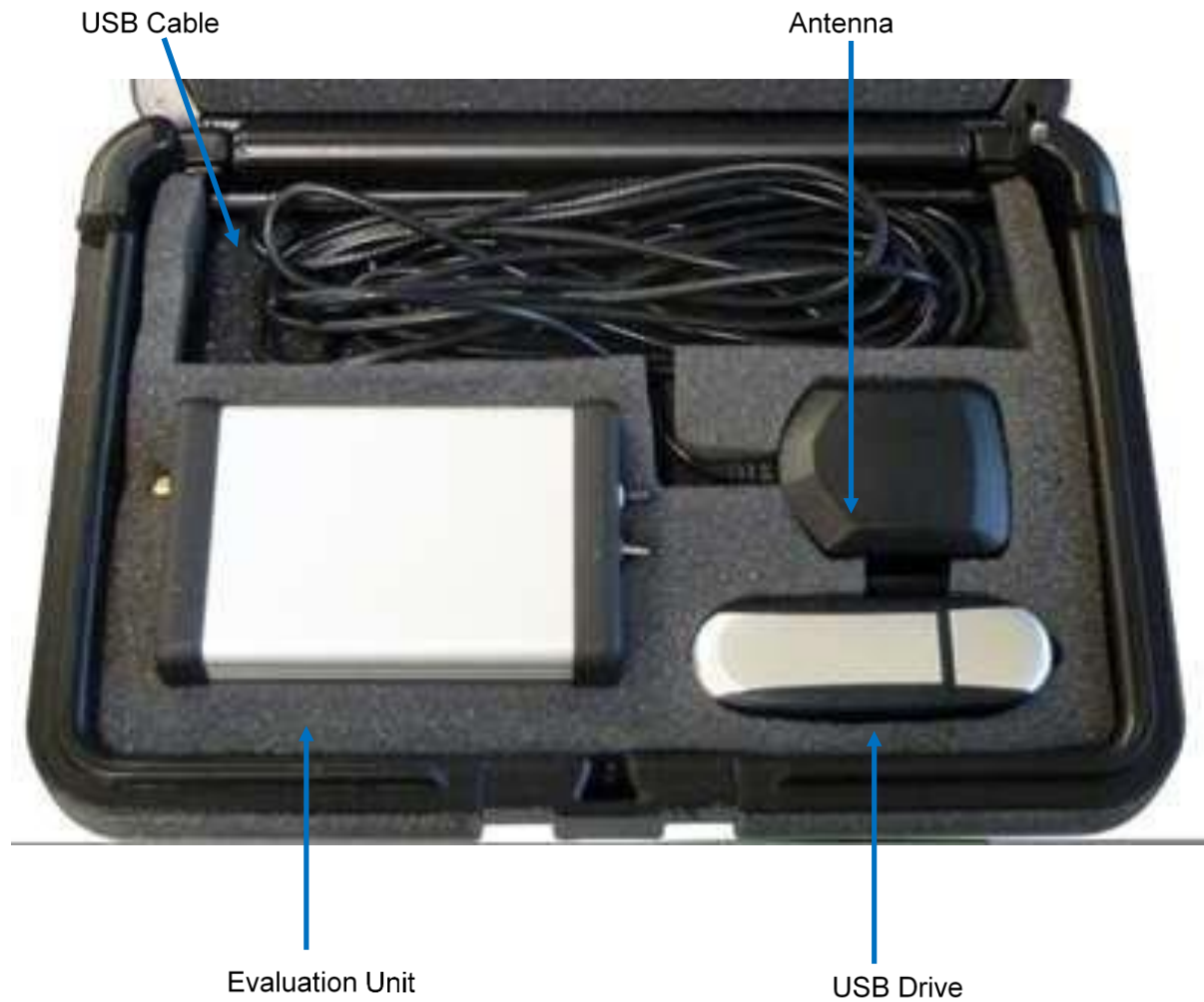

Figure 2-2 SL869-ADR Module Photo

3. EVALUATION KIT (EVK)



The EVK includes a cable to attach vehicle sensor signals to the evaluation unit.

Figure 3-1 Evaluation Kit (EVK) contents

4. DEAD RECKONING OVERVIEW

Dead reckoning (DR) is the process of estimating one's current position based upon a previously determined position or "fix", and advancing that position from course and speed data (which could be either estimated or measured).

The SL869-ADR receiver provides the user with accurate estimates of vehicle position and velocity (even in the absence of GNSS information) by combining speed and heading sensor data into the navigation solution. With this combined system, the sensor inputs will help smooth over interruptions in the GNSS signals, while the satellite signals will provide updates and corrections for sensor drift. The result is improved navigation in environments such as tunnels and urban canyons

4.1. SL869-ADR Operation

The SL869-ADR operates as a traditional GNSS DR receiver with the addition of height estimation. It has built-in MEMS accelerometers and, gyros along with software to calculate the vehicle speed and heading and thus develop a navigation solution, even during times of satellite outages.

4.2. Example of the DR Function



Green = SL869-V3 (GNSS-only)

Blue = SL869-ADR (MEMS DR)

The green (non-DR) track demonstrates loss of navigation in the two tunnels (the SE-to-NW tracks near the top of the route), and significant multipath effects on the West side of the route.

These blue (DR) tracks show continuous nav fixes even in the tunnels, and corrected ground tracks where the GNSS signal alone results in position errors.

DR also shows improved ground tracks in an extreme urban canyon – the small square in the middle of the West side of the route.

5. PRODUCT FEATURES

5.1. Multi-Constellation Navigation

GPS and GLONASS constellations are enabled by default.

The user may enable or disable GPS, GLONASS, and/or BDS constellations via command. Using GLO or BDS alone may not give optimum positioning results depending on the region where the receiver is located.

5.2. Quasi-Zenith Satellite System (QZSS) support

The satellites of the Japanese SBAS are in a highly inclined geosynchronous orbit, allowing continuous coverage over Japan using only three satellites. The signals may be used for ranging. QZSS ranging is disabled by default, but can be enabled via **OSP MID 222,16** command.

5.3. Satellite Based Augmentation System (SBAS)

The receiver is capable of using SBAS satellites both as a source of differential corrections and satellite ranging measurements. These systems (WAAS, EGNOS, GAGAN and MSAS) use geostationary satellites to transmit regional corrections via a GNSS-compatible signal.

5.3.1. SBAS Corrections

The SBAS satellites transmit a set of differential corrections to their respective regions. The use of SBAS corrections can improve positioning accuracy.

5.3.2. SBAS Ranging

The use of SBAS satellites can augment the number of measurements available for the navigation solution, thus improving availability and accuracy.

5.4. Assisted GPS (AGPS)

A GNSS receiver requires ephemeris data to calculate the precise position in space of each satellite to be used in the navigation solution. Since the satellites move at a speed of 3874 km/s along their orbits and are subject to gravitational perturbations from all masses in the solar system, this data must be both current and accurate. Each GPS satellite transmits a complete set of its ephemeris coefficients (called the broadcast ephemeris or BE) every 30 seconds. This is therefore the minimum time required for a cold start Time to First Fix (TTFF). The BE data is usually refreshed every 2 hours.

The minimum cold start TTFF can be reduced from 30 seconds to just a few seconds by implementing AGPS, which can provide Extended Ephemeris (EE) data by two methods -

1. Locally-generated: The receiver includes software to project the future positions of the satellites. This data may be calculated out to 14 days or even longer, depending on the resources available in the receiver, e.g. computation ability and memory.
2. Server-generated: A server calculates the future position projections and makes them available to a receiver, typically over the internet. This data may be good for 30 days, depending on available resources, e.g. communication links and storage.

This Extended Ephemeris (EE) data is then stored for use at the next restart, and can reduce cold start times to a few seconds.

If server-generated EE data is received and processed, locally-generated data is not used.

AGPS is on by default, but can be disabled by command.

5.4.1. **Locally-generated AGPS (ST-AGPS)**

Proprietary algorithms within the module perform GPS ephemeris prediction locally from stored broadcast ephemeris data (received from tracked satellites). The algorithms predict orbital parameters for up to 5 days. The module must operate in Full Power mode for at least 5 minutes to collect ephemeris data from visible satellites, or 12 hours for the full constellation.

5.4.2. **Server-generated AGPS (PGPS/PGLO)**

Telit AGPS servers maintain calculated extended ephemeris data. The predicted ephemeris file is obtained from the AGPS server and is transmitted to the module over serial port 1 (RX). These predictions do not require collection of broadcast ephemeris, and are valid for up to 14 days.

The SL869-ADR supports server-based AGPS as a standard feature.

An Application Note and example source code are available under NDA.

Contact TELIT for support regarding this service.

5.5. **Differential GPS (DGPS)**

Differential corrections can be supplied to the module from an RTCM beacon receiver.

RTCM SC-104 Ver. 2.3 messages 1, 9 and 31 (both GPS and GLONASS) are supported. The module will indicate Differential mode when corrections are supplied.

The use of DGPS corrections can substantially improve position accuracy.

DGPS is disabled by default.

5.6. **Static Navigation**

Static Navigation is an operating mode in which the receiver will freeze the position fix when the speed falls below a set threshold (indicating that the receiver is stationary).

The course and altitude are also frozen, and the speed is reported as "0".

The navigation solution is updated every 40 seconds while the receiver is in the Static Navigation mode.

The navigation solution is unfrozen when the speed increases above a threshold or when the computed position exceeds a set distance from the frozen position (indicating that the receiver is again in motion).

This feature is useful for applications in which very low dynamics are not expected, the classic example being an automotive application.

Static Navigation is disabled by default but can be enabled by command.

5.7. **Elevation Mask Angle**

The default elevation mask angle is 5°. It can be changed by command.

5.8. **Internal LNA**

The module includes a built-in LNA to improve sensitivity.

5.9. **1PPS**

The module provides a 1PPS output signal whenever the receiver has a valid fix (2D or 3D).

5.10. Antenna Enable

The Antenna Enable output can be used to control an external power supply to an active antenna (or external LNA). It will be high when the receiver is operating, or low when it is in a low-power (standby) mode.

5.11. Antenna Sense

The Antenna Sense feature measures the current consumed by the external LNA or active antenna and reports its status as NORMAL, SHORT, or OPEN in an NMEA proprietary message.

5.12. Serial I/O Ports

The module includes two serial ports and an I2C port.

Please refer to § .I/O Port Operation for port details 10.8

5.12.1. UART

The UART ports are used for sending data and receiving commands. UART ports are full-duplex with configurable baud rates. The signal input and output levels are LVTTTL compatible. Note that the idle state of the interface lines is logic high. Care must be used to prevent backdriving the RX line(s) when the module is powered down or in a low-power state.

5.12.2. I²C

The I²C port is dedicated to communication with the built-in MEMS sensors and is brought out for monitoring purposes only.

6. MODULE ORIENTATION, MOUNTING, AND CALIBRATION

6.1. Module Orientation

The SL869-ADR module should be mounted so that the Pin-1 indication dot marked on the module cover is facing the left-hand side of the vehicle.

The sensor frame axes are defined as follows:

- X = Pitch
- Y = Roll
- Z = Yaw (Heading)

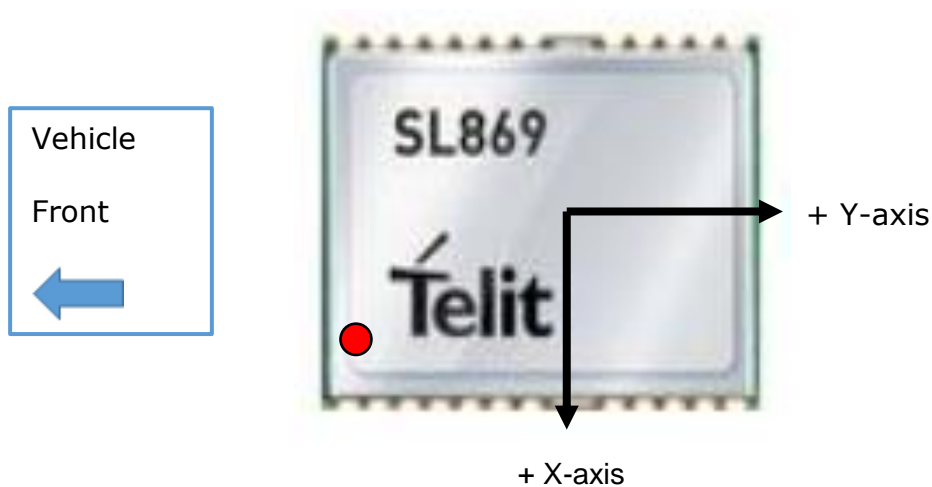
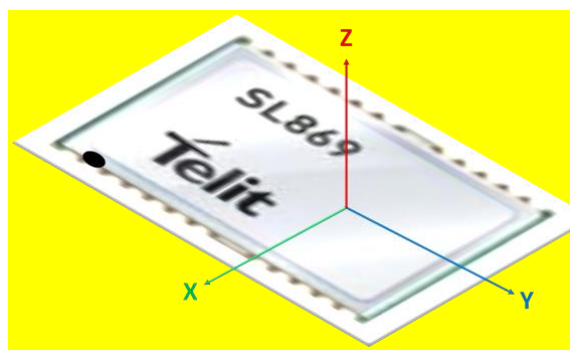

Figure 6-1 Module Orientation



Z-axis is up

Figure 6-2 Module Vertical axis

6.2. Module Mounting

The SL869-ADR module should be securely mounted to a stable part of the vehicle.

The best position is over the center of the vehicle.

For optimal performance, it should be mounted flat (level when the vehicle is on a level surface), but can deviate up to $\pm 45^\circ$ in pitch (about the lateral axis).

Orthogonal orientations are possible but require input of configuration commands to describe the mounting position. For details of commands, please see the SL869-ADR Software Interface User Guide.

6.3. Module Calibration

Please refer to the Calibration procedure in the **SL869-ADR EVK User Guide**

7. SOFTWARE INTERFACE

The primary UART port (TX/RX) supports full duplex communication between the receiver and the user.

The default UART configuration is: 115,200 bps, 8 data bits, no parity, and 1 stop bit.

Customers that have executed a Non-Disclosure Agreement (NDA) with Telit may obtain the V33 Software Authorized User Guide, which contains additional proprietary information

7.1. NMEA Output Messages

The communication protocol is NMEA-0183 V3.01.

7.1.1. NMEA Standard Messages

Message ID	Description	Default
RMC	GNSS Recommended Minimum navigation data	ON
GGA	GNSS Position fix data	ON
GSA	GNSS Dilution of Precision (DOP) and active	ON
GSV	GNSS Satellites in view.	ON
Note: Multiple GSA and GSV messages may be output per cycle.		

Table 7-1 Default NMEA Output Messages

The following messages can be enabled by command:

Message ID	Description	Default
GNS	GNSS Fix data	OFF
GST	GNSS Pseudorange Error Statistics	OFF
GLL	Geographic Position – Latitude & Longitude	OFF
VTG	Course Over Ground & Ground Speed	OFF
ZDA	Time, Date, & Local Time Zone	OFF

Table 7-2 Available Messages

7.1.2. NMEA Talker IDs

Talker ID	Constellation
GA	Galileo
BD	BeiDou
GL	GLONASS
GP	GPS
QZ	QZSS
GN	Solutions using multiple constellations

Table 7-3 NMEA Talker IDs

7.2. Proprietary Messages

The receiver can issue several proprietary NMEA output messages (\$PSTM) which report additional receiver data and status information.

7.3. NMEA Input Commands

The receiver uses NMEA proprietary messages for commands and command responses. This interface provides configuration and control over selected firmware features and operational properties of the module.

The format of a command is:

```
$<command-ID>[,<parameters>]*<cr><lf>
```

Commands are NMEA proprietary format and begin with “\$PSTM”.

Parameters, if present, are comma-delimited as specified in the NMEA protocol.

8. PRODUCT PERFORMANCE

8.1. Horizontal Position Accuracy

Constellation	Typical CEP (m)
GPS	1.3m
GPS + GLONASS	1.6m
Test Conditions: Open Sky, Full Power	

Table 8-1 SL869-ADR Horizontal Position Accuracy

8.2. Time to First Fix

Constellations(s)	Start Type	Typical TTFF (seconds)
GPS	Hot	1
	Warm	25
	Cold	31
GPS + GLO	Hot	1.9
	Warm	25
	Cold	34
GPS + BDS	Hot	2.2
	Warm	28
	Cold	34
Test Conditions: Static scenario, -130 dBm, Full Power mode		

Table 8-2 SL869-ADR Time To First Fix

8.3. Sensitivity

Constellation(s)	State	Minimum Signal Level (dBm)
GPS	Acquisition	-147
	Navigation	-158
	Tracking	-162
GLONASS	Acquisition	-146
	Navigation	-157
	Tracking	-159
GPS + GLO	Acquisition	-147
	Navigation	-158
	Tracking	-162
Test conditions: Static scenario, Full power mode		

Table 8-3 SL869-ADR Sensitivity

9. FLASH UPGRADABILITY

The firmware stored in the internal flash memory of the SL869-ADR may be upgraded via the main serial port (TX/RX).

During normal operation, the BOOT pin should be left floating. This will ensure that the module executes code from its internal flash memory.

In order to update the FW, the following steps should be performed.

1. Remove all power to the module.
2. Connect a serial port cable to a PC.
3. Pull the BOOT SELECT pin high (to VCC through a 1K Ω resistor).
4. Apply main power.
5. Clearing the entire flash memory prior to re-programming is strongly recommended.
6. Run the software utility to re-flash the module.
7. Remove main power to the module for a minimum of 10 seconds.
8. Remove the pullup resistor to the BOOT SELECT pin.
9. Apply main power to the module.
10. Verify that the module has returned to normal operation.

Alternate re-programming method:

1. Apply main power to the module.
2. Connect a serial port cable to a PC.
3. Pull the BOOT SELECT pin high (to VCC through a 1K Ω resistor).
4. Assert nRESET (pull low), then release (floating). nRESET should not be held low.
5. Clearing the entire flash memory prior to re-programming is strongly recommended.
6. Run the software utility to re-flash the module.
7. Return the BOOT SELECT pin to normal (floating).
8. Verify that the module has returned to normal operation.

10. ELECTRICAL INTERFACE

10.1. SL869-ADR Pin-out Diagram

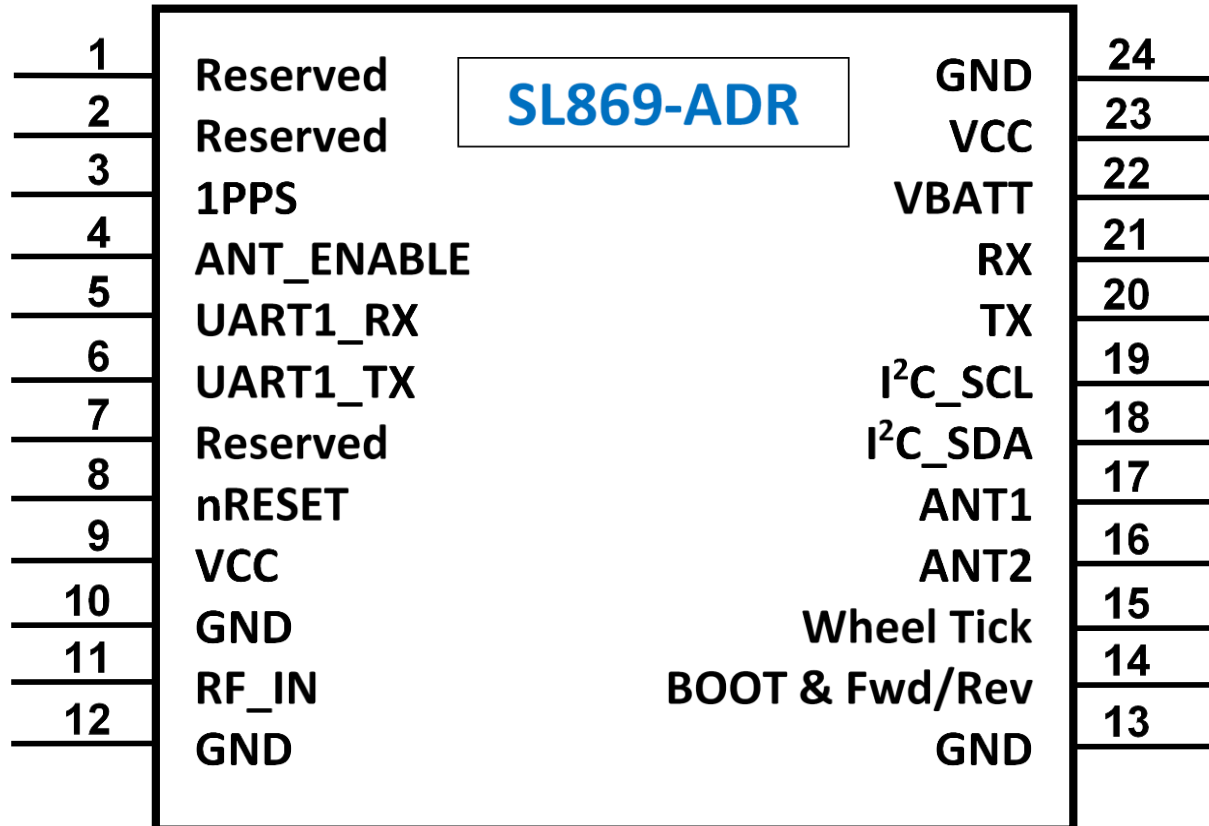

Figure 10-1 SL869-ADR Pin-out Diagram

10.2. SL869-ADR Pin-out Table

Pad	Name	Type	Description
1	Reserved	Res	Reserved – Do not connect
2	Reserved	Res	Reserved – Do not connect
3	1PPS	O	Time Mark Pulse
4	ANT_ENABLE	O	Antenna Enable
5	UART1_RX	I	UART1 Receive
6	UART1_TX	O	UART1 Transmit
7	Reserved	Res	Reserved – Do not connect
8	nRESET	I	Reset (active low)
9	VCC	PWR	Main 3.3 V Supply Voltage
10	GND	GND	Ground
11	RF_IN	I	GNSS RF Input, 50 Ohm
12	GND	GND	Ground
13	GND	GND	Ground
14	BOOT / Fwd / Rev	I	BOOT (at power up) Forward / Reverse signal (Fwd = low)
15	Wheel Tick	I	Wheel Tick input pulse
16	ANT2	I	Antenna sense 2
17	ANT1	I	Antenna sense 1
18	I ² C_SDA	I/O	I ² C Data (Internal MEMS Sensors)
19	I ² C_SCL	I/O	I ² C Clock (Internal MEMS Sensors)
20	TX	O	(Main) UART0 Transmit
21	RX	I	(Main) UART0 Receive
22	VBATT	PWR	Battery Backup Supply
23	VCC	PWR	Main 3.3 V Supply Voltage
24	GND	GND	Ground
Note: All GND pins must be connected to Ground.			
Note: Pins 3, 14, and 20 must be LOW when power is applied (for normal operation)			

Table 10-1 SL869-ADR Pin-out Table

10.3. DC Characteristics

Signal	Description	Min	Typ	Max	Units
V_{OL}	Low level output voltage, I_{OL} 2mA	-	-	0.4	V
V_{OH}	High level output voltage, I_{OH} 2mA	$0.75 \cdot V_{DD}$	-	-	V
V_{IL}	Low level input voltage	-0.3	-	0.45	V
V_{IH}	High level input voltage, I_{IH} 2mA	$0.7 \cdot V_{DD}$	-	3.6	V
R_{PU}	Internal pull-up resistor equivalent		47		k Ω
R_{PD}	Internal pull-down resistor equivalent		47		k Ω
L_I	Input leakage at $V_I = 1.8$ V or 0 V	-10	-	10	μ A
L_O	Tristate output leakage at $V_O = 1.8$ V or 0 V	-10	-	10	μ A
C_I	Input capacitance, digital output	-	8	-	pF

Table 10-2 DC Characteristics

10.4. Absolute Maximum Ratings

Parameter	Pins	Max Rating	Units
RF Input Voltage	All RF inputs	1.5	V
RF Input Power	All RF inputs	10	dBm
ESD Voltage CDM JESD22-C101E	All Pins	+/- 1100	V
ESD Voltage HDM JEDEC JS-001-2012	All Pins	+/-500	V
3.3 V Supply Voltage	VCC	3.6	V
I/O Pin Voltage	All digital inputs	3.60	V

Table 10-3 Absolute Maximum Ratings

10.5. Power Supply

10.5.1. VCC

This is the primary 3.3V power supply for the module.

The SL869-ADR includes a switching voltage regulator that supplies the required voltage to the GNSS device and other internal items. These power supply components (including capacitors) are internal to the module.

The external DC voltage supply (including regulators, capacitors, etc.) must be designed to ensure that stable power is maintained within the specifications listed below.

The supply voltage must be within specification within 10 milliseconds of initial application.

The power-up sequence must not be interrupted during the first second or the module may fail to start up. If the module does not initialize correctly due to improper application of VCC_IN, the module can be reset by:

- removing power from both Vcc and Vbatt and then reapplying it in the proper manner
- or
- asserting the nRESET pin (low).

See § 10.5.3 DC Power Requirements for power specifications.

Pin 9 is connected to pin 23 by an internal trace, and may (optionally) be connected to the external supply for pin 23.

10.5.2. VBATT

The Battery Backup supply voltage is used to power the RTC and BBRAM domains. It maintains critical data to enable HOT and WARM starts.

Internal diode OR'ing provides an internal source for VBATT even if this pin is not used.

An internal reset of the module is generated upon removal and reapplication of VBATT (not VCC_IN). If the module does not initialize correctly due to improper application of VCC_IN, the module can be reset by:

- removing power from both Vcc and Vbatt and then reapplying it in the proper manner
- or
- asserting the nRESET pin (low).

See § 10.5.3 DC Power Requirements for power specifications.

10.5.3. DC Power Requirements

Name	Min	Typ	Max	Units
VCC	3.0	3.3	3.6	V
VBATT	2.5	3.3	3.6	V

Table 10-4 DC Supply Voltage

10.5.4. DC Power Consumption

State & Constellation	Typ	Max	Units
Acquisition			
GPS Only	188	244	mW
GPS + Glonass	162	215	mW
GPS + BeiDou	178	238	mW
Navigation/Tracking			
GPS Only	158	211	mW
GPS + Glonass	132	185	mW
GPS + BeiDou	155	208	mW
Standby (Vbatt)	221		uW
Operating temperature: 25°C. Supply voltage: 3.3 VDC nominal			

Table 10-5 Power Consumption

10.6. RF interface

10.6.1. RF IN

The RF input (RF-IN) pin accepts GNSS L1 band signals from the GPS, GLONASS, BeiDou, Galileo, and QZSS constellations at a level between -125 dBm and -165 dBm into 50 Ω impedance.

DC voltage to the RF input is blocked by an internal capacitor.

The SL869-ADR contains an integrated LNA and pre-select SAW filter. This allows the module to work well with a passive or active GNSS antenna. If the antenna cannot be located near the module, then an active antenna (that is, an antenna with a built in low noise amplifier) should be used.

Antenna Gain:

- Passive antenna: isotropic gain of greater than -6 dBi.
- Active antenna: optimum gain is 15 dB to 20 dB (including cable losses).
- A noise figure of less than 1.0 dB will offer the best performance.



The maximum total external gain is 24 dB (including all external gain - i.e. antenna gain, external LNA gain, and any passive losses due to cables, connectors, filters, matching networks, etc.).

10.6.2. External Active Antenna Voltage

If an active antenna or external LNA is used, an external source is required to provide voltage to it. This may be the same source that is used to supply the module, or it may be a separate source. A DC blocking capacitor is not required since it is built-in to the module.

10.6.3. Burnout Protection

The receiver accepts without risk of damage a signal of +10 dBm from 0 to 2 GHz carrier frequency, except in band 1560 to 1610 MHz where the maximum level is -10 dBm.

10.6.4. Frequency Plan

Signal	Frequency (MHz)
TCXO Frequency	26.000
LO Frequency	1571.328

Table 10-6 Frequency Plan

10.6.5. Local Oscillator Leakage

Signal	Typical (dBm)
LO Leakage	-70dBm (typical)

Table 10-7 LO Leakage

10.7. Antenna Interface

10.7.1. Antenna Enable

The Antenna Enable output can be used to control an external power supply to an active antenna (or external LNA, etc.). It will be high when the receiver is operating, or low when it is in a low-power (standby) mode.

10.7.2. Antenna Sense

The Antenna Sense feature will measure the current consumed by the external LNA or active antenna using two comparators with hysteresis. With 3.3 V supplied, a 1 Ω sense resistor yields input voltages to indicate the state of the antenna. The FW reads these lines and provides an output message for antenna NORMAL, OPEN, or SHORTED.

This message can be configured to be output periodically or whenever the status changes.

Please refer to § **Error! Reference source not found. Error! Reference source not found.** for details.

The **Antenna Sense application note** is available under a Non-Disclosure Agreement.

10.8. Control and Status signals



10.8.1. Startup Requirements

For normal startup, pins 3, 14, and 20 must be LOW. They have internal pulldowns.

10.8.2. nRESET



Asserting nRESET (pull low, then release) will clear the contents of SRAM and RTC.

The module will begin operation with a cold start after nRESET is released.

Since the BOOT SELECT pin is read when nRESET is released, it must be set to the desired input level (LOW for normal operation) before nRESET is released.

Holding nRESET low will not place the module in a low-power state.

10.8.3. Boot Select

Low for normal operation. This pin has an internal pulldown.

Pull high to load FW into flash memory. Note: This pin is used for Wheel Tick input after the boot process is completed. See § Flash Upgradability for usage.

10.8.4. 1PPS

1PPS is a one pulse per second signal which is enabled after the receiver has achieved a 2D or 3D position fix. It is disabled if the position fix is lost.

The pulse is approximately 25% duty cycle.

10.9. Vehicle Sensor Signals

10.9.1. Forward / Reverse

Note: This pin is used for BOOT SELECT during the startup process, and must be low during that time for normal operation.

After boot is complete, it is used to input a signal indicating the vehicle's FORWARD (low) or REVERSE (high) state. Please see § Reference Design and the Interface Board schematic in the SL869-ADR EVK User Guide for examples of signal conditioning circuitry.

10.9.2. Wheel Tick

This pin is used to input a signal indicating the speed of the vehicle. The signal could be sourced from the transmission, wheel revolution sensors, etc. or even the CAN bus with a user-supplied interface device. Telit does not provide these interface boxes.

10.10. I/O Port Operation

10.10.1. UART Port Operation

The SL869-ADR provides two UART ports UART0 (TX/RX): Pins 20 & 21.

- This is the primary communications port which outputs data and accepts commands in NMEA format.
- The UART can operate at rates from 4800 bps to 1.2288 Mbps.
- This is the primary communications port which outputs data and accepts commands in NMEA format.
-
- UART1 (UART1_TX & RX): Pins 6 & 5.
- DGPS corrections input in the RTCM SC-104 format may be sent to this port.
- Default speed = 115,200 bps.
-

Note: Pins 14 & 15 (which are a UART on the SL869-V3) are BOOT and Reserved respectively on the SL869-ADR.



If the RX signal is used, it is important that it be either high impedance or logic low whenever VCC_IN has been removed from the device. Failure to follow this requirement can lead to improper receiver operation upon next power-up.

10.10.2. I²C Port Operation

The I²C port on pins 18 and 19 is dedicated to the internal MEMS devices and may only be used for test purposes. Internal pullups are included.

The connections required to operate the SL869-ADR properly are:

- Power and Ground
- RF Input
- TX/RX communications
- Vehicle signals – Forward / Reverse and Wheel Tick

The power supply shown is a minimal design for the SL869-ADR power requirements. The power supply must have tight voltage regulation under varying line and load conditions to prevent falsely tripping the internal voltage supervisor within the SL869-ADR.

The RF input can be connected directly to a GNSS antenna. The reference design shows a DC power feed for an active antenna which is controlled by both the antenna sense circuit and the module Antenna Enable signal. The inductor L1 is chosen to be self-resonant at the GPS frequency, 1.57542 GHz, to minimize loading on the RF trace. Capacitor C5 is also chosen to be self-resonant at the GPS frequency so that it is close to an RF short at that frequency.

V_ANT is the supply voltage for the external active antenna.

TX and RX are typical UART digital I/O lines.

As is the case with all RX lines, the idle state is logic one.

Be careful to tri-state this line if the SL869-ADR is turned off to avoid back-driving.

The Forward / Reverse input signal from the vehicle must be low for Forward and high for Reverse.

The Wheel Tick pulse provides speed input to the SL869-ADR module.

12. RF FRONT END DESIGN

12.1. RF Signal Requirements

The receiver can achieve Cold Start acquisition with a signal level above the specified minimum at its input. This means that it can acquire and track visible satellites, download the necessary ephemeris data and compute the location within a 5-minute period. In the GNSS signal acquisition process, demodulating the navigation message data is the most difficult task, which is why Cold Start acquisition requires a higher signal level than navigation or tracking. For the purposes of this discussion, autonomous operation is assumed, which makes the Cold Start acquisition level the dominant design constraint. If assistance data in the form of time or ephemeris aiding is available, lower signal levels can be used for acquisition.

The GPS signal is defined by IS-GPS-200. This document states that the signal level received by a linearly polarized antenna having 3 dBi gain will be a minimum of

-130 dBm when the antenna is in the worst-case orientation and the satellite is 5 degrees or more above the horizon.

In actual practice, the GPS satellites transmit slightly more power than specified, and the signal level typically increases if a satellite has higher elevation angles.

The GLONASS signal is defined by GLONASS ICD. Version 5.1 dated 2008 is current as of 2016. This document states that the power level of the received RF signal from GLONASS satellite at the output of a 3 dBi linearly polarized antenna is not less than

-131 dBm for L1 sub-band provided that the satellite is observed at an angle 5 degrees or more above the horizon.

The BeiDou signal is defined in the BDS ICD. Version 2.0 dated Dec 2013 is current as of 2016. It specifies signal levels that are similar to those of GPS and GLONASS.

The receiver will display a reported C/No of 40 dB-Hz for a GPS signal level of -130 dBm at the RF input. This assumes a SEN (system equivalent noise) of the receiver of 4 dB. System Equivalent Noise includes the Noise Figure of the receiver plus signal processing or digital noise. For an equivalent GLONASS signal level the GLONASS signal will report a C/No of approximately 39 dB-Hz. This is due to the receiver's higher losses (NF) for GLONASS signals and a higher signal processing noise for GLONASS signals.

Each GNSS satellite presents its own signal to the receiver, and best performance is obtained when the signal levels are between -130 dBm and -125 dBm. These received signal levels are determined by:

- GNSS satellite transmit power
- GNSS satellite elevation angle
- Free space path loss
- Extraneous path loss (such as rain)
- Partial or total path blockage (such as foliage or buildings)
- Multipath interference (caused by signal reflection)
- GNSS antenna characteristics
- Signal path after the GNSS antenna

The satellite transmit power is specified in each constellation's reference documentation, readily available online.

The GNSS signal is relatively immune to attenuation from rainfall.

However, the GNSS signal is heavily influenced by attenuation due to foliage (such as tree canopies, etc.) as well as outright blockage caused by buildings, terrain or other items near the line of sight to the specific GNSS satellite. This variable attenuation is highly dependent upon satellite location. If enough satellites are blocked, say at a lower elevation, or all in one general direction, the geometry of the remaining satellites will result in a lower position accuracy. The receiver reports this geometry effect in the form of PDOP, HDOP and VDOP numbers.

For example, in a vehicular application, the GNSS antenna may be placed on the dashboard or rear package tray of an automobile. The metal roof of the vehicle will cause significant blockage, plus any thermal coating applied to the vehicle glass can attenuate the GNSS signal by as much as 15 dB. Again, both of these factors will affect the performance of the receiver.

Multipath interference is a phenomenon where the signal from a particular satellite is reflected and is received by the GNSS antenna in addition to or in place of the line of sight signal. The reflected signal has a path length that is longer than the line of sight path and can either attenuate the original signal, or, if received in place of the original signal, can add error in determining a solution because the distance to the particular satellite is actually shorter than measured. It is this phenomenon that makes GNSS navigation in urban canyons (narrow roads surrounded by high-rise buildings) so challenging. In general, the reflection of a GNSS signal causes the polarization to reverse. The implications of this are covered in the next section.

12.2. GNSS Antenna Polarization

The GNSS broadcast signals are Right Hand Circularly Polarized (RHCP).

An RHCP antenna will have 3 dB gain compared to a linearly polarized antenna (assuming the same antenna gain specified in dBic and dBi respectively).

An RHCP antenna is better at rejecting multipath interference than a linearly polarized antenna because the reflected signal changes polarization to LHCP. This signal would be rejected by the RHCP antenna, typically by 20 dB or greater.

In a multipath situation, the direct (line of sight) signal would show a higher signal level with an RHCP antenna than a linearly polarized antenna because the interfering signal is rejected.

However, in the case where the line of sight signal is obstructed, such as in an urban canyon environment, then the number of satellites in view could drop below the minimum needed to determine a 3D position. This is a case where a bad signal may be better than no signal. The system designer needs to understand trade-offs in their application to determine the better choice.

12.3. Active versus Passive Antenna

If the GNSS antenna is placed near the receiver (within 1 or 2 meters) and the RF trace losses are not excessive (nominally 1 dB), then a passive antenna may be used. This would often be the lowest cost option and most of the time the simplest to use. However, if the antenna needs to be located farther away from the receiver, then an active antenna may be required to obtain the best system performance. An active antenna includes a built-in low noise amplifier (LNA) to overcome RF trace and cable losses. Many active antennas also have a pre-select filter, a post-select filter, or both.

Important specifications for an active antenna LNA are gain and noise figure.

12.4. GNSS Antenna Gain

Antenna gain is defined as the amplified signal power from the antenna compared to a theoretical isotropic antenna (equally sensitive in all directions).

Optimum performance is realized when the firmware build and hardware configuration match the type of antenna used (active or passive). Most receivers automatically adjust the internal LNA gain to accommodate the incoming signal level.

For example, a 25 mm by 25 mm square patch antenna on a reference ground plane (usually 70 mm by 70 mm) may give an antenna gain at zenith of 5 dBic. A smaller 18 mm by 18 mm square patch on a reference ground plane (usually 50 mm by 50 mm) may give an antenna gain at zenith of 2 dBic.

An antenna vendor should specify a nominal antenna gain (usually at zenith, or directly overhead) and antenna pattern curves specifying gain as a function of elevation, and gain at a fixed elevation as a function of azimuth. Pay careful attention to the requirement to meet the required design, such as ground plane size and any external matching components. Failure to follow these requirements could result in very poor antenna performance.

It is important to note that GNSS antenna gain is not the same as external LNA gain. Most antenna vendors will specify these numbers separately, but some combine them into a single number. Both numbers are significant when designing the front end of a GNSS receiver.

For example, antenna X has an antenna gain of 5 dBic at azimuth and an LNA gain of

20 dB for a combined total of 25 dB. Antenna Y has an antenna gain of -5 dBic at azimuth and an LNA gain of 30 dB for a combined total of 25 dB. However, in the system, antenna X will outperform antenna Y by about 10 dB (Refer to the next section for more details on external LNA gain).

An antenna with higher gain will generally outperform an antenna with lower gain. However, once the signals are above about -130 dBm for a particular satellite, no improvement in performance would be realized. However, for those satellites with a signal level below about -135 dBm, a higher gain antenna would amplify the signal and improve the performance of the GNSS receiver. In the case of very weak signals, a good antenna could mean the difference between being able to use a particular satellite signal or not.

12.5. RF Trace Losses

RF Trace losses on a PCB are difficult to estimate without having appropriate tables or RF simulation software. A good rule of thumb would be to keep the RF traces as short as possible, make sure they are 50 Ω impedance, and don't contain any sharp bends.

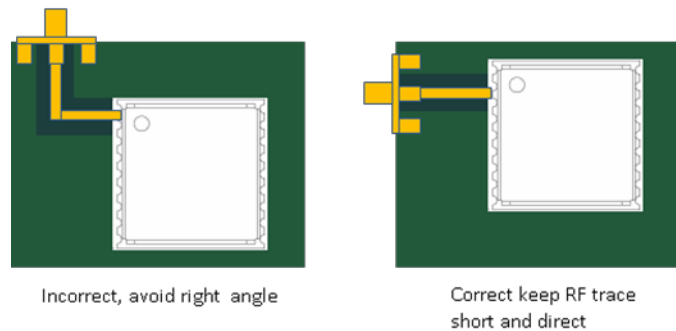

Figure 12-1 RF Trace Examples

12.6. PCB stack and Trace Impedance

It is important to maintain a 50 Ω impedance on the RF path trace. Design software for calculating trace impedance can be found from multiple sources on the internet. The best method is to contact your PCB supplier and request a stackup for a 50 Ω controlled impedance board. They will give you a suggested trace width along with PCB stackup needed to create the 50 Ω impedance.

It is also important to consider the effects of component pads that are in the path of the 50 Ω trace. If the traces are shorter than a 1/16th wavelength, transmission line effects will be minimized, but stray capacitance from large component pads can induce additional RF losses. It may be necessary to ask the PCB vendor to generate a new PCB stackup and suggested trace width that is closer to the component pads, or modify the component pads themselves.

12.7. Powering an External LNA (active antenna)

An external LNA requires a source of power. Many active antennas accept a 3 V or 5 V DC voltage that is impressed upon the RF signal line.

Two approaches can be used:

1. Use an inductor to tie directly to the RF trace. This inductor should be at self-resonant at L1 (1.57542 GHz) and should have good Q for low loss. The higher the inductor Q, the lower the loss will be. The side of the inductor connecting to the antenna supply voltage should be bypassed to ground with a good quality RF capacitor, again with self-resonance at the L1 frequency.

2. Use a quarter wave stub in place of the inductor. The length of the stub is designed to be exactly $\frac{1}{4}$ wavelength at L1, which has the effect of making an RF short at one end of the stub to appear as an RF open at the other end. The RF short is created by a high quality RF capacitor operating at self-resonance.

The choice between the two would be determined by:

- RF path loss introduced either by the inductor or by the quarter wave stub.
- Cost of the inductor.
- Space availability for the quarter wave stub.

Simulations done by Telit show the following:

Inductor	Additional signal loss (dB)
Murata LQG15HS27NJ02	0.65
Quarter wave stub on FR4	0.59
Coilcraft B09TJLC (used in ref. design)	0.37

Table 12-1 Inductor Loss

Since this additional loss occurs after the LNA, it is generally not significant unless the circuit is being designed to work with both active and passive antennas.

12.8. RF Interference

RF interference into the GNSS receiver tends to be the biggest problem when determining why the system performance is not meeting expectations. As mentioned earlier, the GNSS signals are at a level of -130 dBm and lower. If signals higher than this are presented to the receiver, the RF front end can be overdriven.

The most common source of interference is digital noise, often created by the fast rise and fall times and high clock speeds of modern digital circuitry. For example, a popular netbook computer uses an Atom processor clocked at 1.6 GHz. This is only 25 MHz away from the GNSS signal, and depending upon temperature of the SAW filter, can be within its passband. Because of the nature of the address and data lines, this would be broadband digital noise at a relatively high level.

Such devices are required to adhere to a regulatory standard for emissions such as FCC Part 15 Subpart J Class B or CISPR 22. However, these regulatory emission levels are far higher than the GNSS signal.

12.9. Shielding

Shielding the RF circuitry generally is ineffective because the interference is received by the GNSS antenna itself (which is the most sensitive portion of the RF path). The antenna cannot be shielded because it could not then receive the GNSS signals.

There are two solutions, one is to move the antenna away from the source of interference, and the other is to shield the digital interference source to prevent it from getting to the antenna.

13. MECHANICAL DRAWING

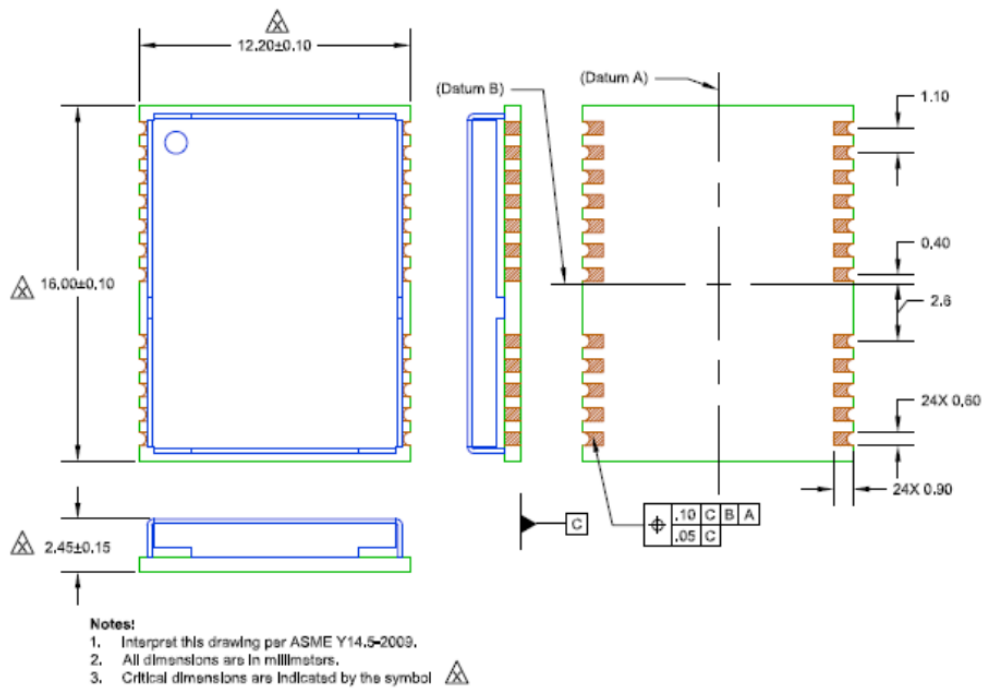

Figure 13-1 SL869-ADR Mechanical Drawing

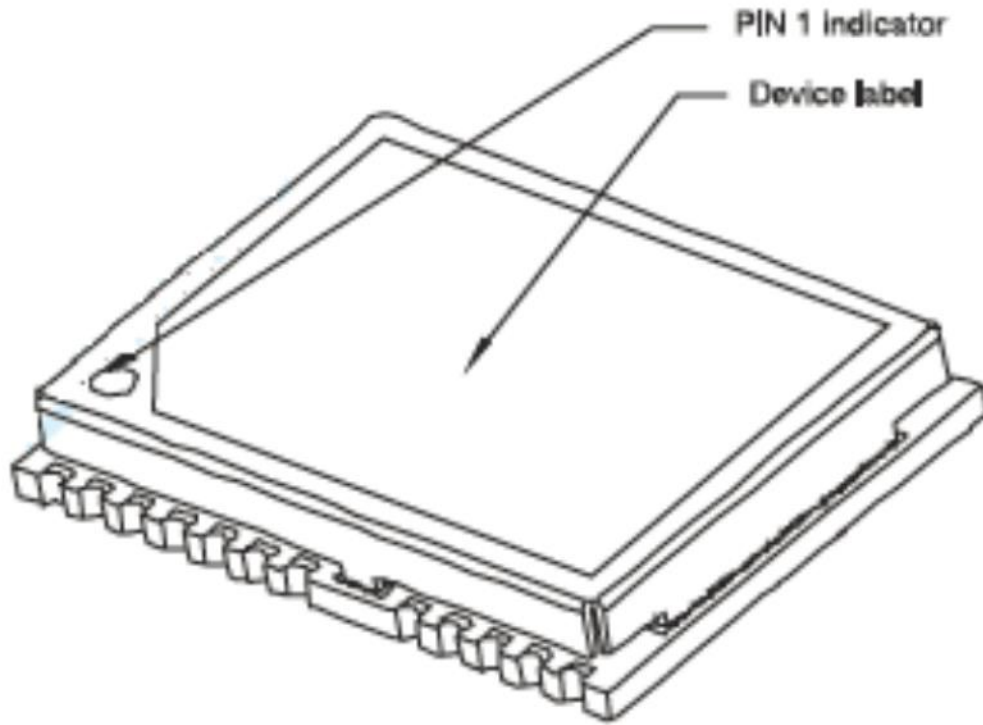

Figure 13-2 3-D Mechanical Drawing

14. PCB FOOTPRINT

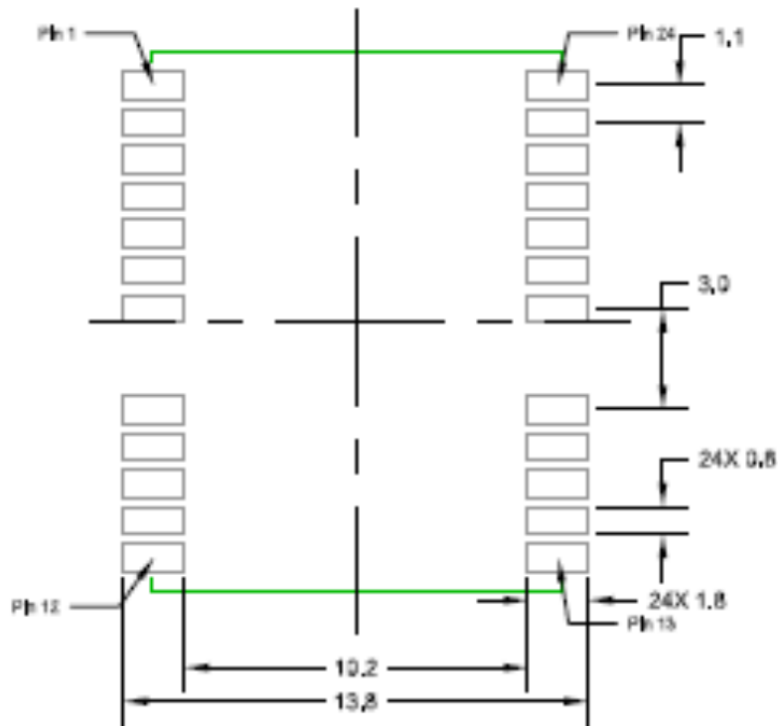

Figure 14-1 SL869-ADR PCB Footprint

The module uses advanced packaging with a base metal of copper and an Electroless Nickel Immersion Gold (ENIG) finish.

15. PRODUCT PACKAGING AND HANDLING

15.1. Product Marking and Serialization

The SL869-ADR module label has a 2D Barcode identifying the module and its serial number.

Contact a Telit representative for information on specific module serial numbers.

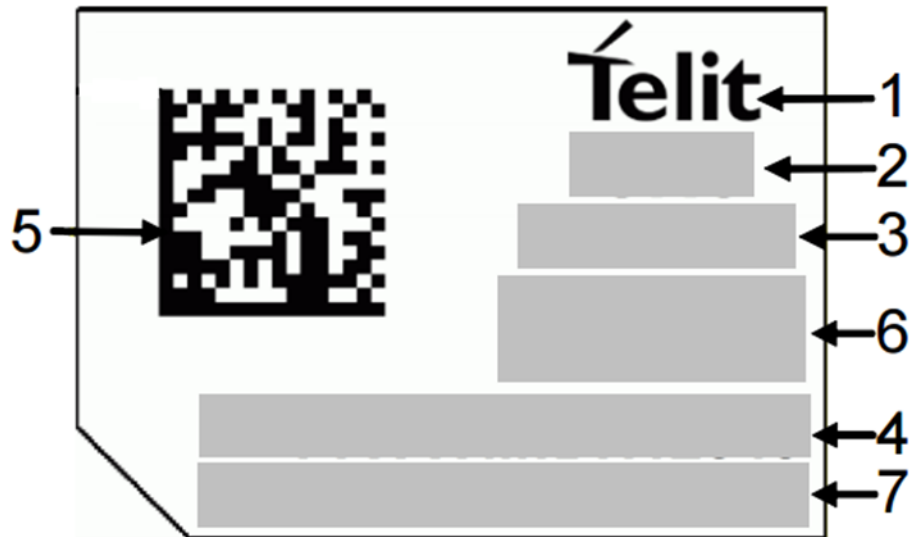

Figure 15-1 Product Label

Key	Description
1	Telit logo
2	Product Name
4	Telit Serial Number
5	Telit Serial Number barcode (type 2D datamatrix) 11 digit (base 36 – 0 to 9 followed by A to Z)
6	CE mark
Note: Other fields are unused	

15.2. Product Packaging

SL869-ADR modules are shipped in Tape and Reel form on 24 mm reels with 1000 units per reel or Trays with 72 units. Each reel or tray is 'dry' packaged and vacuum sealed in a Moisture Barrier Bag (MBB) with two silica gel packs and a humidity indicator card, which is then placed in a carton.

All packaging is ESD protective lined.

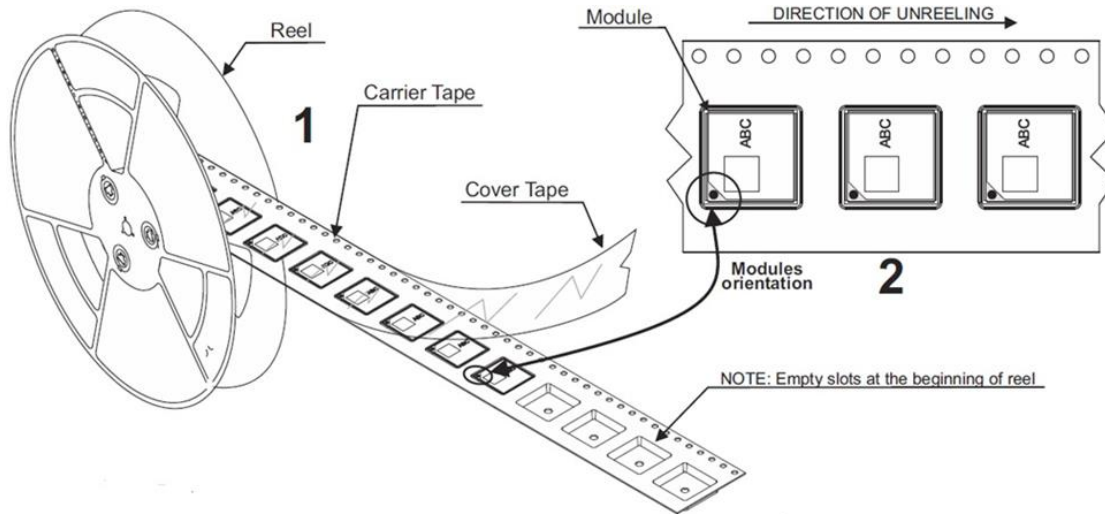

Figure 15-2 Tape and Reel Packaging

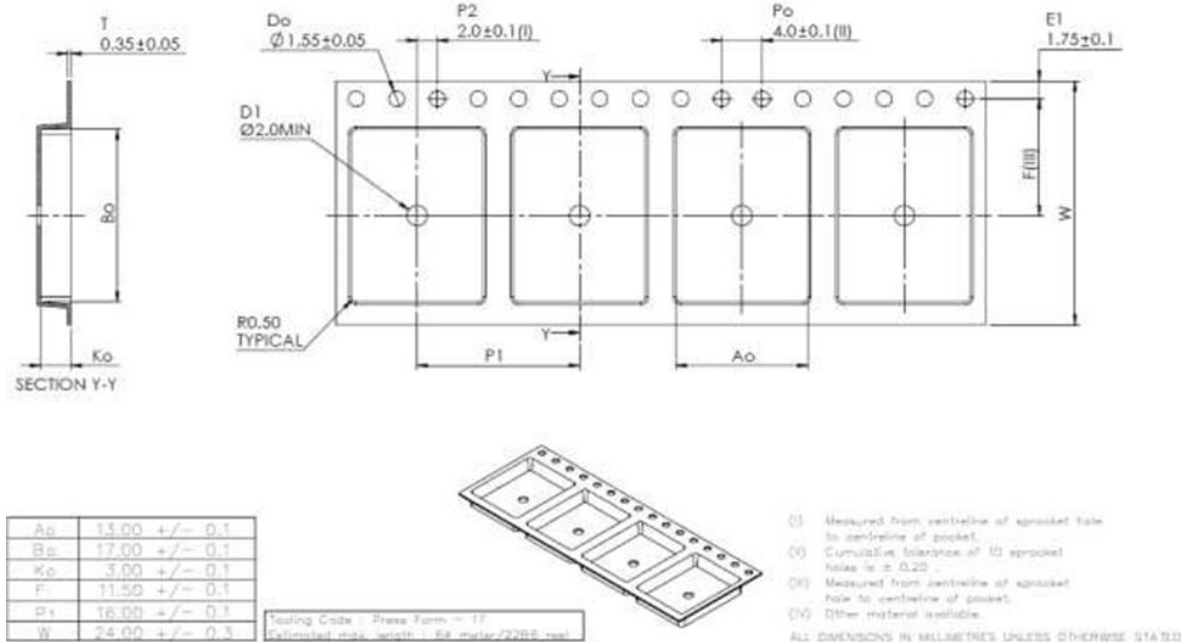

Figure 15-3 Tape and Reel – Tape detail

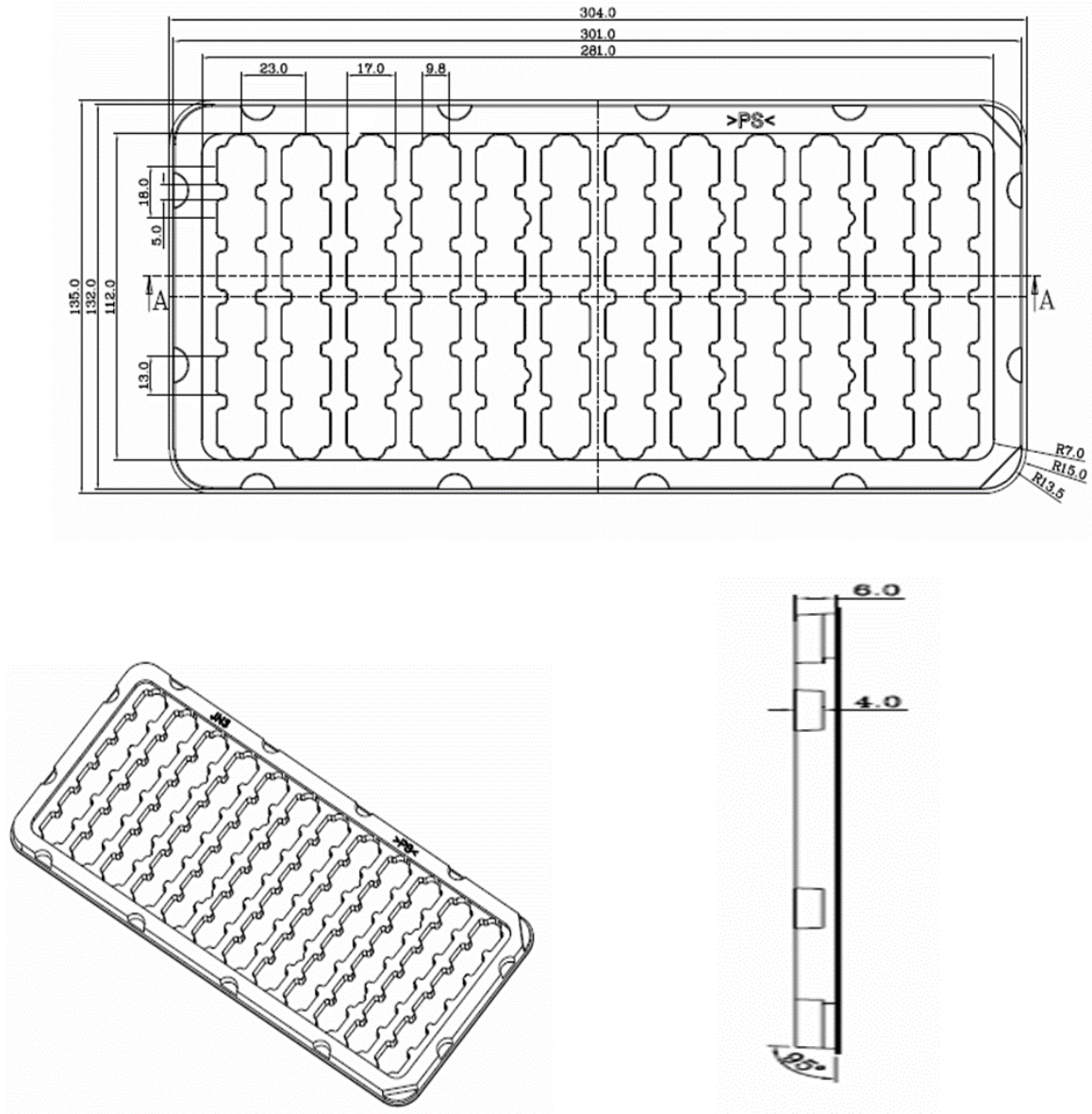

Figure 15-4 Tray Packaging

15.3. Moisture Sensitivity

Precautionary measures are required in handling, storing and using these devices to avoid damage from moisture absorption. If localized heating is required to rework or repair the

device, precautionary methods are required to avoid exposure to solder reflow temperatures that can result in performance degradation.

The Telit module has a moisture sensitivity level rating of 3 as defined by **IPC/JEDEC J-STD-020**. This rating is assigned due to some of the components used within the module.

The TELIT packaging is hermetically sealed with desiccant and humidity indicator card. The TELIT parts must be placed and reflowed within 168 hours of first opening the hermetic seal provided the factory conditions are less than 30°C and less than 60% and the humidity indicator card indicates less than 10% relative humidity.

If the package has been opened or the humidity indicator card indicates above 10%, then the parts must be baked prior to reflow. The parts may be baked at +125°C ± 5°C for 48 hours. However, the tape and reel cannot withstand that temperature. Lower temperature baking is feasible if the humidity level is low and time is available. Please see **IPC/JEDEC J-STD-033** for additional information.

Additional information can be found on the MSL tag affixed to the outside of the hermetically sealed bag.

JEDEC standards are available free of charge from the JEDEC website <http://www.jedec.org>.

	CAUTION	LEVEL
	This bag contains MOISTURE-SENSITIVE DEVICES	<div style="border: 1px solid black; padding: 5px; display: inline-block; font-size: 24pt; font-weight: bold;">3</div>
		If Blank, see adjacent bar code label
<ol style="list-style-type: none"> 1. Calculated shelf life in sealed bag: 12 months at < 40 °C and < 90% relative humidity (RH) 2. Peak package body temperature: _____ °C If Blank, see adjacent bar code label 3. After bag is opened, devices that will be subjected to reflow solder or other high temperature process must <ol style="list-style-type: none"> a) Mounted within: <u>168</u> hours of factory If Blank, see adjacent bar code label conditions ≤ 30 °C/60% b) stored at <10% RH 4. Devices require bake, before mounting, if: <ol style="list-style-type: none"> a) Humidity Indicator Card is > 10% when read at 23 ± 5 °C b) 3a or 3b not met. 5. If baking is required, devices may be baked for 48 hours at 125 ± 5 °C 		
Note: If device containers cannot be subjected to high temperature or shorter bake times are desired, reference IPC/JEDEC J-STD-033 for bake procedure		
Bag Seal Date: _____ <small>If Blank, see adjacent bar code label</small>		
Note: Level and body temperature defined by IPC/JEDEC J-STD-020		

Figure 15-5 Moisture-Sensitive Device Label

15.4. ESD Sensitivity

The module contains class 1 devices and is classified as Electro-Static Discharge Sensitive (ESDS).

Telit recommends the two basic principles of protecting ESD devices from damage:

Handle sensitive components only in an ESD Protected Area (EPA) under protected and controlled conditions;

Protect sensitive devices outside the EPA using ESD protective packaging.

All personnel handling ESDS devices have the responsibility to be aware of the ESD threat to the reliability of electronic products.

Further information can be obtained from the JEDEC standard JESD625-A Requirements for Handling Electrostatic Discharge Sensitive (ESDS) Devices.

15.5. Reflow

The modules are compatible with lead free soldering processes as defined in **IPC/JEDEC J-STD-020**. The reflow profile must not exceed the profile given **IPC/JEDEC J-STD-020** Table 5-2, "Classification Reflow Profiles". Although **IPC/JEDEC J-STD-020** allows for three reflows, the assembly process for the module uses one of those profiles, therefore the module is limited to two reflows.

When re-flowing a dual-sided SMT board, it is important to reflow the side containing the module last. This prevents heavier components within the module from becoming dislodged if the solder reaches liquidus temperature while the module is inverted.

Note: JEDEC standards are available free from the JEDEC website <http://www.jedec.org>.

15.6. Assembly Considerations

During board assembly and singulation process steps, pay careful attention to unwanted vibrations, resonances and mechanical shocks introduced by the board router.

15.7. Washing Considerations

The module can be washed using standard PCB cleaning procedures after assembly. The shield does not provide a water seal to the internal components of the module, so it is important that the module be thoroughly dried prior to use by blowing excess water and then baking the module to drive residual moisture out. Depending upon the board cleaning equipment, the drying cycle may not be sufficient to thoroughly dry the module, so additional steps may need to be taken. Exact process details will need to be determined by the type of washing equipment as well as other components on the board to which the module is attached. The module itself can withstand standard JEDEC baking procedures.

15.8. **Safety**

Improper handling and use of this module can cause permanent damage to it. There is also the possible risk of personal injury from mechanical trauma or choking hazard.

See Section 19 Safety Recommendations for safety information.

15.9. **Disposal**

We recommend that this product should not be treated as household waste. For more detailed information about recycling this product, please contact your local waste management authority or the reseller from whom you purchased the product.

16. ENVIRONMENTAL REQUIREMENTS

16.1. Operating Environmental Limits

Temperature	-40°C to +85°C
Temperature Rate of Change	±1°C / minute maximum
Humidity	Up to 95% non-condensing or a wet bulb temperature of +35°C, whichever is less
Maximum Vehicle Dynamics	2G acceleration

Table 16-1 Operating Environmental Limits

16.2. Storage Environmental Limits

Temperature	-40°C to +85°C
Humidity	Up to 95% non-condensing or a wet bulb temperature of +35°C, whichever is less
Shock (in shipping container)	10 drops from 75 cm onto concrete floor

Table 16-2 Storage Environmental Limits

17. COMPLIANCES

The SL869-ADR module complies with the following:

- Directive 2002/95/EC on the restriction of the use of certain hazardous substances in electrical and electronic equipment (RoHS)
- Manufactured in an ISO 9000: 2008 accredited facility
- Manufactured to TS 16949 requirement (upon request)

The module conforms to the following European Union Directives:

- Low Voltage Directive 2006/95/EEC and product safety test
- Directive EMC 2004/108/EC for conformity for EMC

18. GLOSSARY AND ACRONYMS

AGPS	<p>Assisted (or Aided) GPS</p> <p>AGPS provides ephemeris data to the receiver to allow faster cold start times than would be possible using only broadcast data. This extended ephemeris data could be either server-generated or locally-generated.</p> <p>See Local Ephemeris prediction data and Server-based Ephemeris prediction data</p>
Almanac	<p>A reduced-precision set of orbital parameters for the entire GPS constellation that allows calculation of approximate satellite positions and velocities. The almanac may be used by a receiver to determine satellite visibility as an aid during acquisition of satellite signals. The almanac is updated weekly by the Master Control Station. See Ephemeris.</p>
BeiDou (BDS / formerly COMPASS)	<p>The Chinese GNSS, currently being expanded towards full operational capability.</p>
Cold Start	<p>A cold start occurs when a receiver begins operation with unknown position, time, and ephemeris data, typically when it is powered up after a period on inactivity. Almanac information may be used to identify previously visible satellites and their approximate positions. See Restart.</p>
Cold Start Acquisition Sensitivity	<p>The lowest signal level at which a GNSS receiver is able to reliably acquire satellite signals and calculate a navigation solution from a Cold Start. Cold start acquisition sensitivity is limited by the data decoding threshold of the satellite messages.</p>
EGNOS	<p>European Geostationary Navigation Overlay Service</p> <p>The European SBAS system.</p>
Ephemeris (plural ephemerides)	<p>A set of precise orbital parameters that is used by a GNSS receiver to calculate satellite position and velocity. The satellite position is then used to calculate the navigation solution. Ephemeris data is updated frequently (normally every 2 hours for GPS) to maintain the accuracy of the position calculation. See Almanac.</p>
ESD:	<p>Electro-Static Discharge</p> <p>Large, momentary, unwanted electrical currents that can cause damage to electronic equipment.</p>
GAGAN	<p>The Indian SBAS system.</p>
Galileo	<p>The European GNSS currently being built by the European Union (EU) and European Space Agency (ESA).</p>
GDOP	<p>Geometric Dilution of Precision</p> <p>A factor used to describe the effect of satellite geometry on the accuracy of the time and position solution of a GNSS receiver. A lower value of GDOP indicates a smaller error in the solution. Related factors include PDOP, HDOP, VDOP and TDOP.</p>

GLONASS	<p>ГЛОбальная НАвигационная Спутниковая Система GLObal'naya NAvigatsionnaya Sputnikovaya Sistema (Global Navigation Satellite System) The Russian GNSS, which is operated by the Russian Aerospace Defense Forces</p>
GNSS	<p>Global Navigation Satellite System Generic term for a satellite-based navigation system with global coverage. The current or planned systems are: GPS, GLONASS, BDS, and Galileo.</p>
GPS	<p>Global Positioning System The U.S. GNSS, a satellite-based positioning system that provides accurate position, velocity, and time data. GPS is operated by the US Department of Defense.</p>
Hot Start	<p>A hot start occurs when a receiver begins operation with known time, position, and ephemeris data, typically after being sent a restart command. See Restart.</p>
LCC	<p>Leadless Chip Carrier A module design without pins. In place of the pins are pads of bare gold-plated copper that are soldered to the printed circuit board.</p>
LNA	<p>Low Noise Amplifier An electronic amplifier used for very weak signals which is especially designed to add very little noise to the amplified signal.</p>
Local Ephemeris prediction data	<p>Extended Ephemeris (i.e. predicted) data, calculated by the receiver from broadcast data received from satellites, which is stored in memory. It is usually useful for up to three days. See AGPS.</p>
MSAS	<p>MTSAT Satellite Augmentation System The Japanese SBAS system.</p>
MSD	<p>Moisture sensitive device.</p>
MTSAT	<p>Multifunctional Transport Satellites The Japanese system of geosynchronous satellites used for weather and aviation control.</p>
Navigation Sensitivity	<p>The lowest signal level at which a GNSS receiver is able to reliably maintain navigation after the satellite signals have been acquired.</p>
NMEA	<p>National Marine Electronics Association</p>
QZSS	<p>Quasi-Zenith Satellite System The Japanese SBAS system (part of MSAS).</p>
Reacquisition	<p>A receiver, while in normal operation, loses RF signal (perhaps due to the antenna cable being disconnected or a vehicle entering a tunnel), and re-establishes a valid fix after the signal is restored. Contrast with Reset and Restart.</p>
Restart	<p>A receiver beginning operation after being sent a restart command, generally used for testing rather than normal operation. A restart can also result from a power-up. See Cold Start, Warm Start, and Hot Start. Contrast with Reset and Reacquisition.</p>

Reset	A receiver beginning operation after a (hardware) reset signal on a pin, generally used for testing rather than normal operation. Contrast with Restart and Reacquisition.
RoHS	The Restriction of Hazardous Substances Directive on the restriction of the use of certain hazardous substances in electrical and electronic equipment, was adopted in February 2003 by the European Union.
RTC	Real Time Clock An electronic device (chip) that maintains time continuously while powered up.
SAW	Surface Acoustic Wave filter Electromechanical device used in radio frequency applications. SAW filters are useful at frequencies up to 3 GHz.
SBAS	Satellite Based Augmentation System A system that uses a network of ground stations and geostationary satellites to provide differential corrections to GNSS receivers. These corrections are transmitted on the same frequency as navigation signals, so the receiver can use the same front-end design to process them. Current examples are WAAS, EGNOS, MSAS, and GAGAN.
Server-based Ephemeris prediction data	Extended Ephemeris (i.e. predicted) data, calculated by a server and provided to the receiver over a network. It is usually useful for up to 14 days. See AGPS.
TCXO	Temperature-Compensated Crystal Oscillator
Tracking Sensitivity	The lowest signal level at which a GNSS receiver is able to maintain tracking of a satellite signal after acquisition is complete.
TTF	Time to First Fix The elapsed time required by a receiver to achieve a valid position solution from a specified starting condition. This value will vary with the operating state of the receiver, the length of time since the last position fix, the location of the last fix, and the specific receiver design. A standard reference level of -130 dBm is used for testing.
UART	Universal Asynchronous Receiver/Transmitter An integrated circuit (or part thereof) which provides a serial communication port for a computer or peripheral device.
WAAS	Wide Area Augmentation System The North American SBAS system developed by the US FAA (Federal Aviation Administration).
Warm Start	A warm start occurs when a receiver begins operation with known (at least approximately) time and position, but unknown ephemeris data, typically after being sent a restart command. See Restart.

19. SAFETY RECOMMENDATIONS

19.1. READ CAREFULLY

Be sure that the use of this product is allowed in the country and in the environment required. The use of this product may be dangerous and must be avoided in the following areas:

- Where it can interfere with other electronic devices in environments such as hospitals, airports, aircraft, etc.
- Where there is risk of explosion such as gasoline stations, oil refineries, etc. It is the responsibility of the user to enforce the country regulations and specific environmental regulations.

Do not disassemble the product. Evidence of tampering will invalidate the warranty.

Telit recommends following the instructions in product user guides for correct installation of the product. The product must be supplied with a stabilized voltage source and all wiring must conform to security and fire prevention regulations. The product must be handled with care, avoiding any contact with the pins because electrostatic discharges may damage the product itself.

The system integrator is responsible for the functioning of the final product; therefore, care must be taken with components external to the module, as well as for any project or installation issue. Should there be any doubt, please refer to the technical documentation and the regulations in force. Non-antenna modules must be equipped with a proper antenna with specific characteristics.

The European Community provides directives for electronic equipment introduced in the market. Relevant information is available on the European Community website:

<http://ec.europa.eu/enterprise/sectors/rte/documents/>

The text of the Directive 99/05 regarding telecommunication equipment is available, while the applicable Directives (Low Voltage and EMC) are available at:

<http://ec.europa.eu/enterprise/sectors/electrical/>

The power supply used shall comply the clause 2.5 (Limited power sources) of the standard EN 60950-1 and shall be mounted on a PCB which complies with V-0 flammability class.

Since the module must be built-in to a system, it is intended only for installation in a RESTRICTED ACCESS LOCATION. Therefore, the system integrator must provide an enclosure which protects against fire, electrical shock, and mechanical shock in accordance with relevant standards.

<http://ec.europa.eu/enterprise/sectors/electrical/>

19.2. **Electrical and Fire Safety**

This device is intended for built-in designs and must be installed by users that have taken adequate precautions and have sufficient knowledge to avoid electrical, mechanical and fire hazards.

The module shall be mounted on a PCB which complies with V-0 flammability class.

The device must be supplied with a limited power source that meets clause 2.5 of the EN 60950-1 standard. These requirements are:

- For power supplies without overcurrent protection device:
Short circuit current < 8 A. Apparent power < 100 VA
- For power supplies with overcurrent protection device (rated current of overcurrent device shall be < 5 A):
Short circuit current < 333 A. Apparent power < 250 VA.
- Furthermore, the device must be installed within an enclosure that meets HB class or pass the 550° glowing fire test of EN 60695-2-11 and mounted on a V1 flammability class material or better.

20. DOCUMENT HISTORY

Revision	Date	Changes
0	2016-08-22	First Issue
1	2016-09-02	Added requirements for normal startup to the Electrical Interface chapter
2	2017-04-07	Added reference to NDA doc in Mounting section Corrected pinout diagram and table: UART1 TX and RX were swapped Corrected reference design: UART1 pins TX and RX were swapped Corrected reference design: I ² C pins CLK and DATA were also swapped Minor text revisions



SUPPORT INQUIRIES

Link to www.telit.com and contact our technical support team for any questions related to technical issues.

www.telit.com



Telit Communications S.p.A.
Via Stazione di Prosecco, 5/B
I-34010 Sgonico (Trieste), Italy

Telit Wireless Solutions Inc.
3131 RDU Center Drive, Suite 135
Morrisville, NC 27560, USA

Telit Wireless Solutions Ltd.
10 Habarzel St.
Tel Aviv 69710, Israel

Telit IoT Platforms LLC
5300 Broken Sound Blvd, Suite 150
Boca Raton, FL 33487, USA

Telit Wireless Solutions Co., Ltd.
8th Fl., Shinyoung Securities Bld.
6, Gukjegeumyung-ro8-gil, Yeongdeungpo-gu
Seoul, 150-884, Korea

Telit Wireless Solutions
Tecnologia e Servicos Ltda
Avenida Paulista, 1776, Room 10.C
01310-921 São Paulo, Brazil

Telit reserves all rights to this document and the information contained herein. Products, names, logos and designs described herein may in whole or in part be subject to intellectual property rights. The information contained herein is provided "as is". No warranty of any kind, either express or implied, is made in relation to the accuracy, reliability, fitness for a particular purpose or content of this document. This document may be revised by Telit at any time. For most recent documents, please visit www.telit.com

Copyright © 2016, Telit