

2. Soldering the headers

Before using your click board™, make sure to solder 1x8 male headers to both left and right side of the board. Two 1x8 male headers are included with the board in the package.

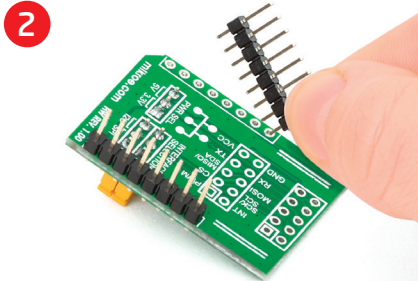

Turn the board upside down so that bottom side is facing you upwards. Place shorter parts of the header pins in both soldering pad locations.

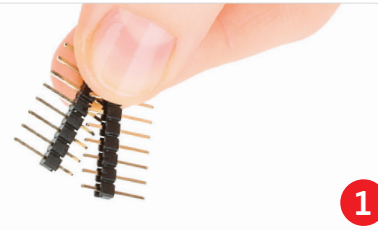
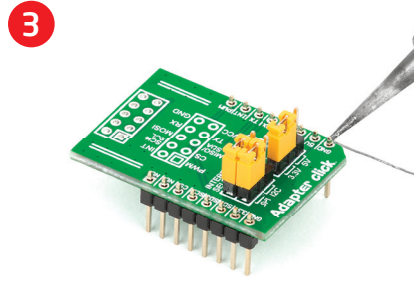

Turn the board upward again. Make sure to align the headers so that they are perpendicular to the board, then solder the pins carefully.

1. Introduction

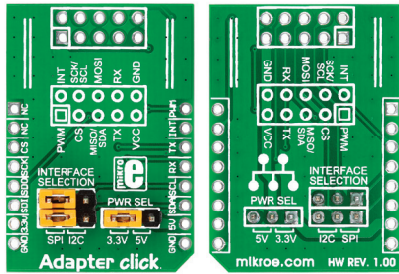

Adapter Click™ is an accessory board in **mikroBUS™** form factor. It's a compact and easy solution for adding mikroBUS™ to IDC10 adapter to your design. It features 2x5 connection pads and two jumpers for SPI/I²C selection. Adapter Click™ communicates with the target board microcontroller via **mikroBUS™** I²C (SDA, SCL), SPI (MISO, MOSI, SCK, CS), UART (RX, TX), INT and PWM lines. The board is designed to use 3.3V and 5V power supply.

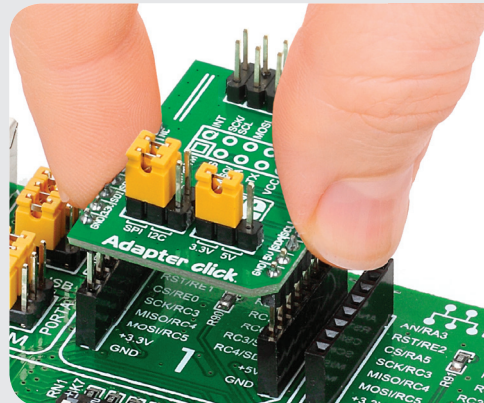

3. Plugging the board in

Once you have soldered the headers your board is ready to be placed into desired mikroBUS™ socket. Make sure to align the cut in the lower-right part of the board with the markings on the silkscreen at the mikroBUS™ socket. If all of the pins are aligned correctly, push the board all the way into the socket.

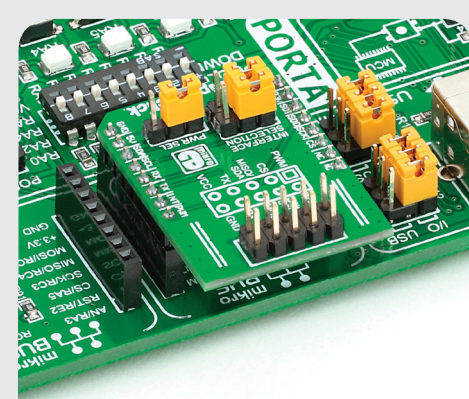

4. Essential features

There are two ways of establishing such connection: using male or female IDC10 connectors. Both are provided with the package. You may solder male IDC10 header on the top side of Adapter Click™ and connect the add-on board directly or via IDC10 flat cable. In some cases, female header socket is a better choice. Solder it either on the top, or the bottom side, depending on which one is more convenient in given circumstances.

click™
BOARD
www.mikroe.com



Adapter click Manual
ver. 1.00



5. Adapter Click™ Board Schematic

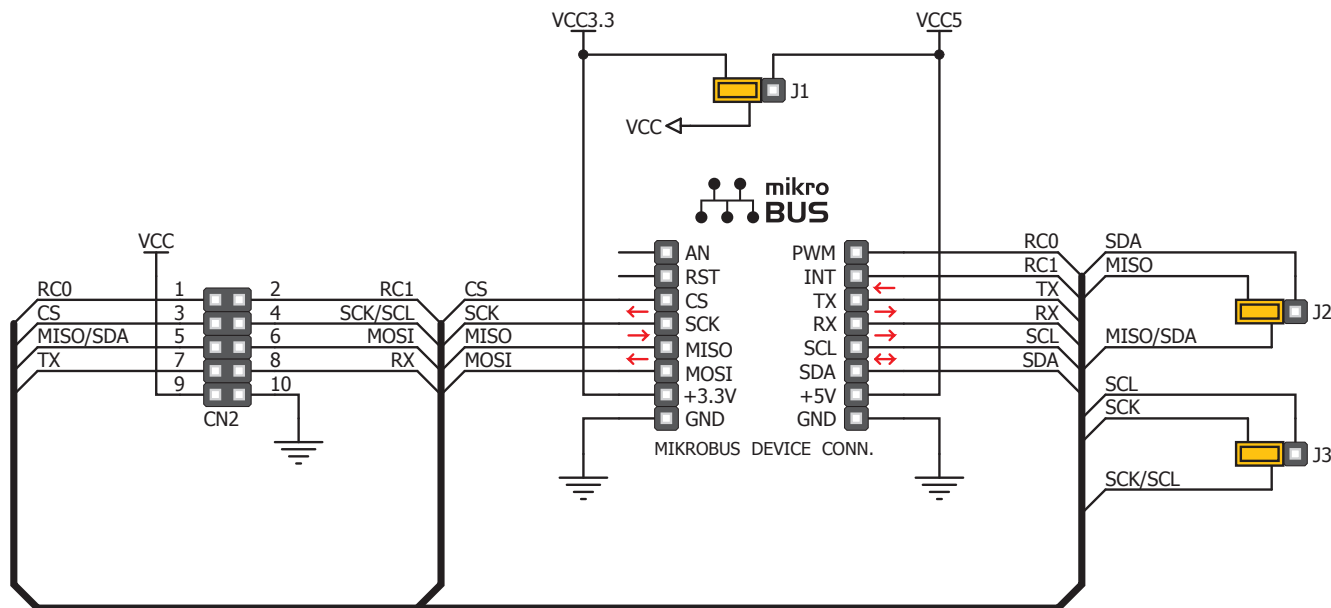

6. Jumpers

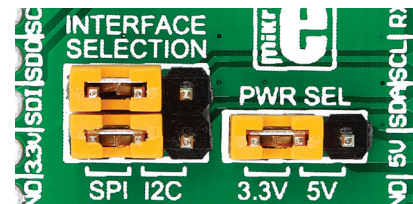

There are two jumpers for SPI/I²C selection and one used to select whether 3.3V or 5V power supply will be used.

7. Code Examples

Once you have done all the necessary preparations, it's time to get your click board up and running. We have provided the examples for mikroC, mikroBasic and mikroPascal compilers on our **Libstock** website. Just download them and you are ready to start.



8. Support

MikroElektronika offers **Free Tech Support** (www.mikroe.com/esupport) until the end of product lifetime, so if something goes wrong, we are ready and willing to help!