

PART NUMBER:
SEE TABLE SHEET 2

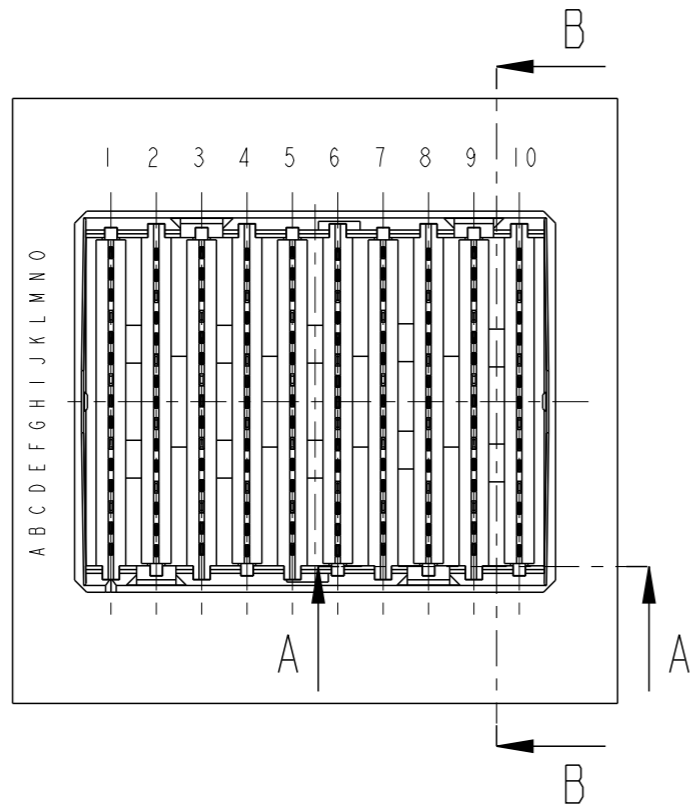

PARTIAL SECTION B-B

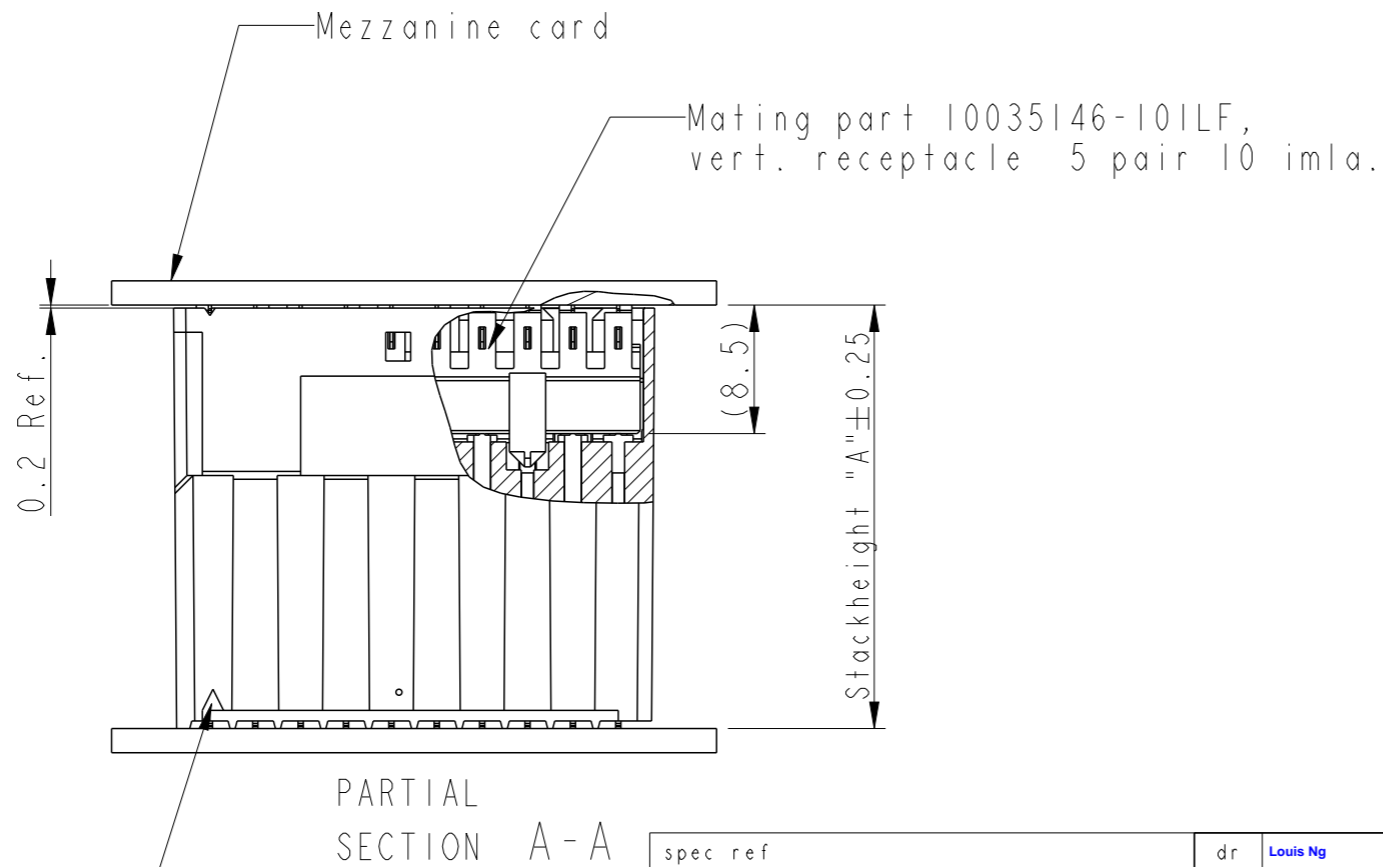
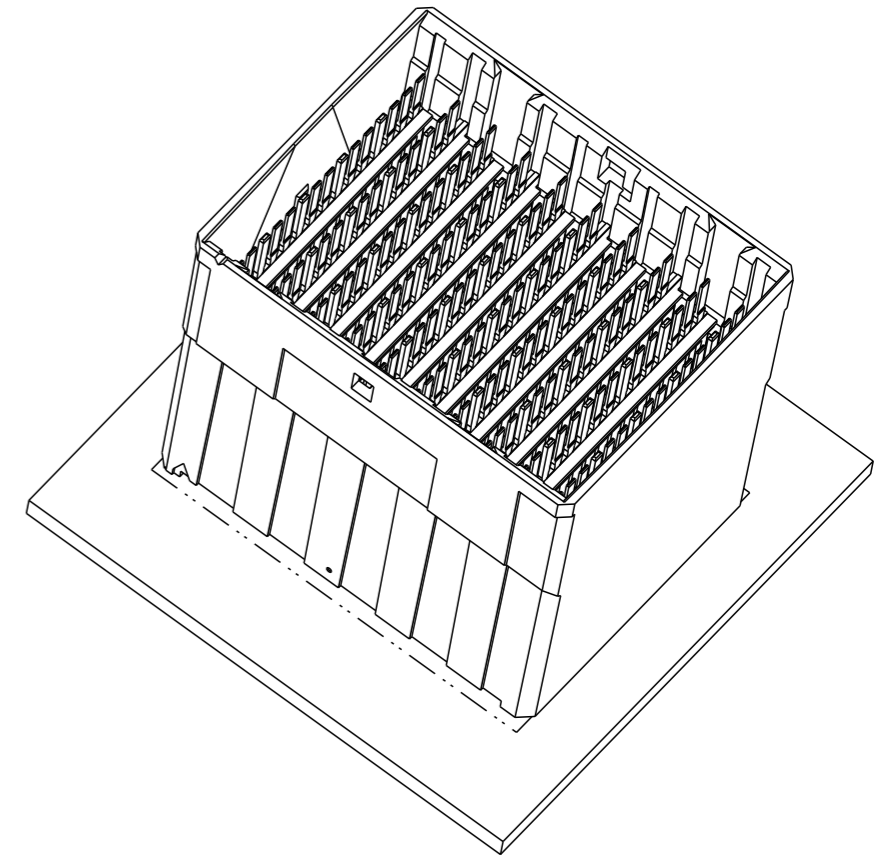
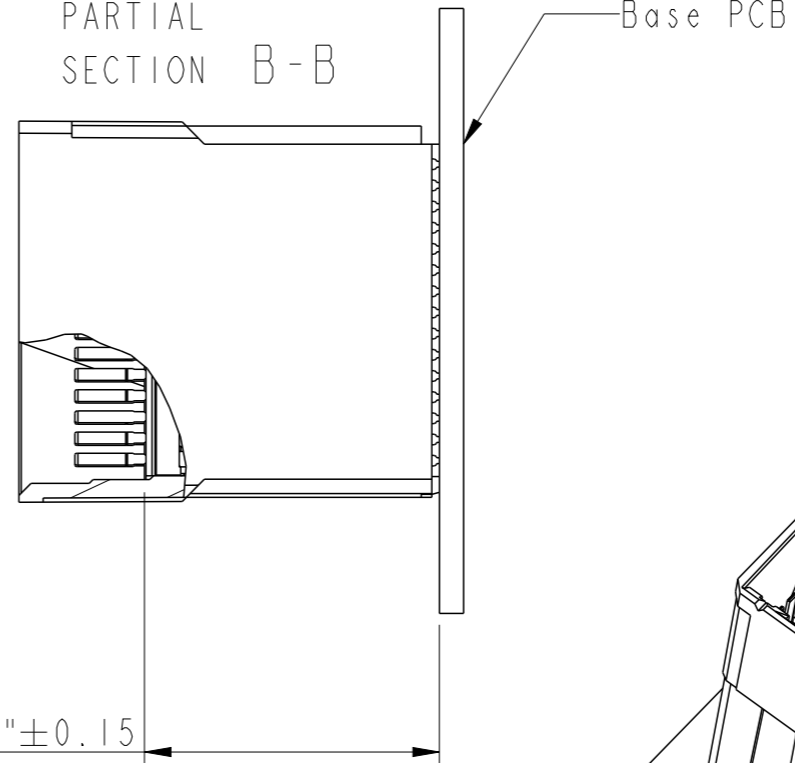

External reference for pin A1

spec ref	dr	Louis Ng	2008/05/08	projection	MM	size	A3	scale	2:1
tolerance std	eng	Matthew Cheong	2012/04/04			ecn no	ELX-S-011204-1	rel level	Released
ISO 406 ISO 1101	chr	-	-						
surface	appr	Chen-Hong Tan	2012/04/09	product family	AirMax	rel level	Released		
	linear	0.X	±		title VHdr 5Pr, 10 IMLA, 3mm AirMax Vs Mezzanine	dwg no 10059957	rev D		
		0.XX	±						
		0.XXX	±						
	angular	0°	±°	www.fci.com	cat. no.	-	Product - Customer Drw	sheet 1 of 4	

PART NUMBER:
SEE TABLE

Views without protection cover

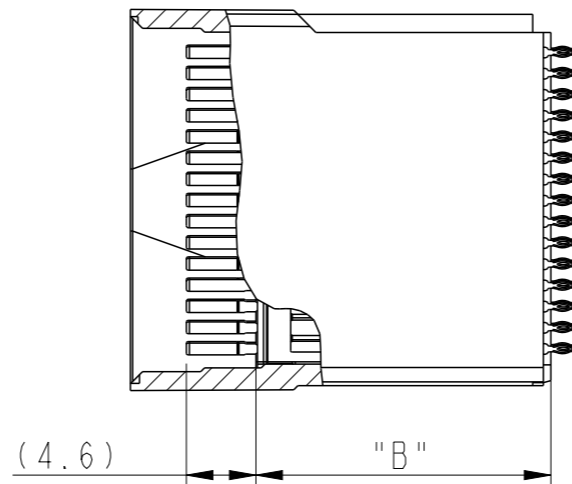
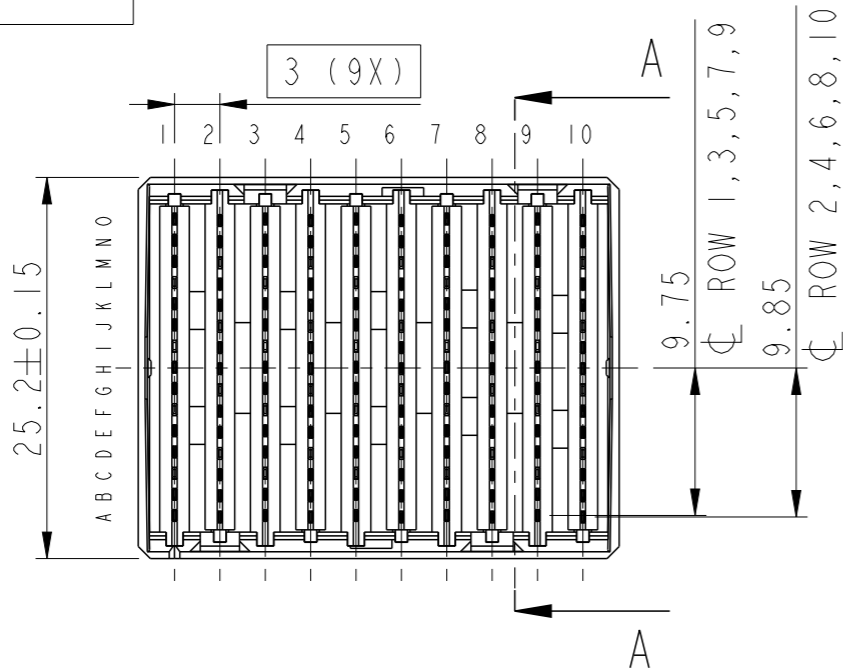

Triangle indicates position A1. See note 10

See note 11

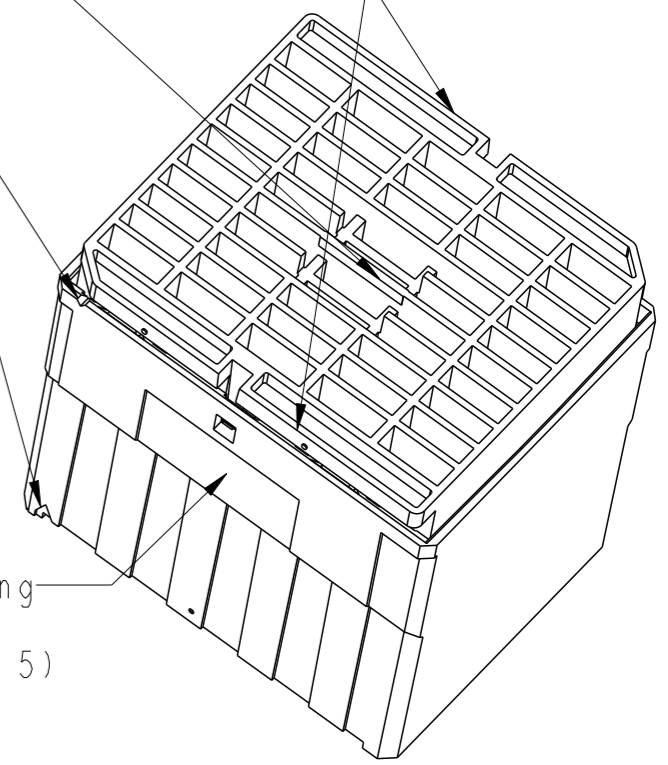

PARTIAL SECTION A-A

P/N Marking Area (See note 5)

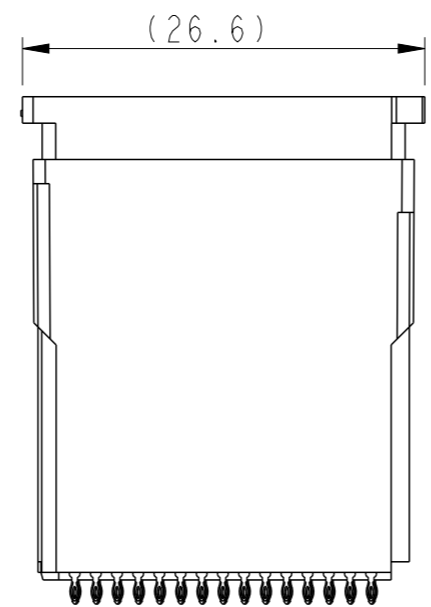
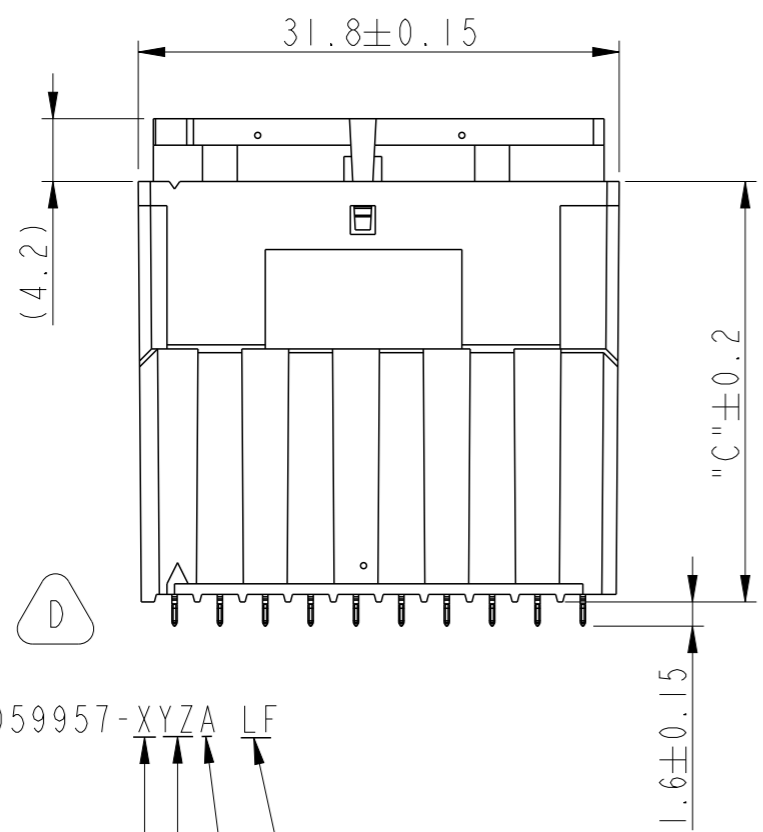

** NOT ALL STACK HEIGHT HAVE BEEN TOOLED UP. FOR PRODUCT AVAILABILITY, PLEASE CHECK FCI WEBSITE.

PRODUCT P/N **	SYSTEM STACK HEIGHT "A"	MATING LEVEL "B"	CONNECTOR HEIGHT "C"
10059957-1011(LF)	14	5.5	13.8
10059957-1021(LF)	16	7.5	15.8
10059957-1031(LF)	18	9.5	17.8
10059957-1041(LF)	20	11.5	19.8
10059957-1051(LF)	22	13.5	21.8
10059957-1061(LF)	24	14.5	23.8
10059957-1071(LF)	26	17.5	25.8
10059957-1081(LF)	28	19.5	27.8
10059957-1091(LF)	30	21.5	29.8
10059957-1101(LF)	25	16.5	24.8

P/N: 10059957-XYZA LF

LF: Lead free product (see note 7)
Protection cover, 0 = not present; 1 = present

Stack height, see table

Plating: 1=Telcordia CO 4 GAS, see note 2.

spec ref	dr	Louis Ng	2008/05/08
tolerance std	eng	Matthew Cheong	2012/04/04
ISO 406	chr	-	-
ISO 1101	appr	Chen-Hong Tan	2012/04/09
TOLERANCES UNLESS OTHERWISE SPECIFIED			
surface	linear	0.X	±
		0.XX	±
		0.XXX	±
angular	0°	±°	

projection	MM	size	A3	scale	2:1
product family	AirMax	ecn no	ELX-S-011204-1		
rel level	Released				
title	VHdr 5Pr, 10 IMLA, 3mm		dwg no	10059957	rev
www.fci.com	cat. no.	-	Product - Customer Drw	sheet 2 of 4	



Copyright FCI.

NOMINAL OUTLINE OF CONNECTOR.
(without protection cover)

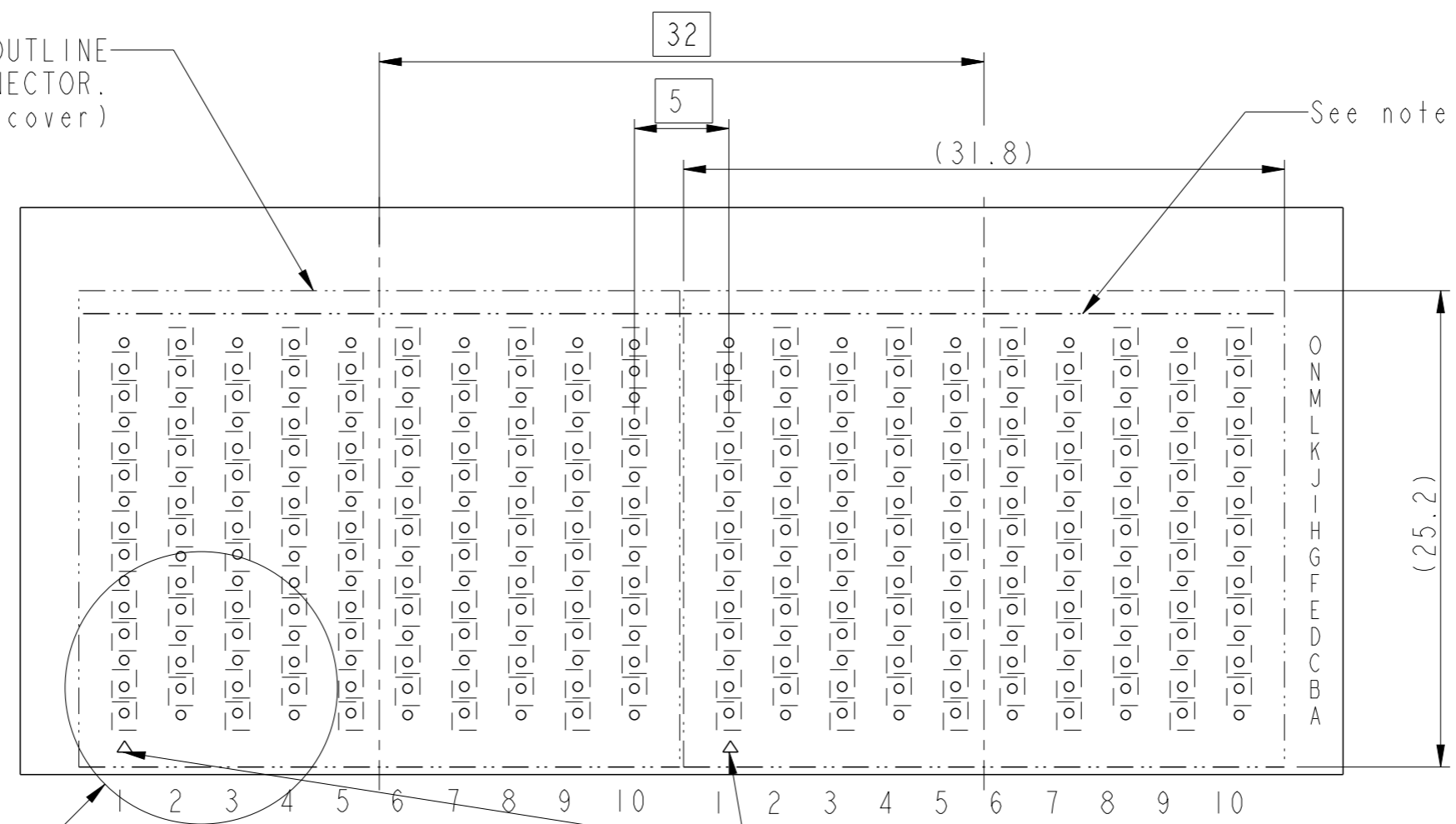

SEE DETAIL B

Triangle indicates position A1.

RECOMMENDED PCB LAYOUT
FOR DIFFERENTIAL APPLICATIONS
COMPONENT SIDE
(TWO ADJACENT FOOTPRINTS SHOWN)

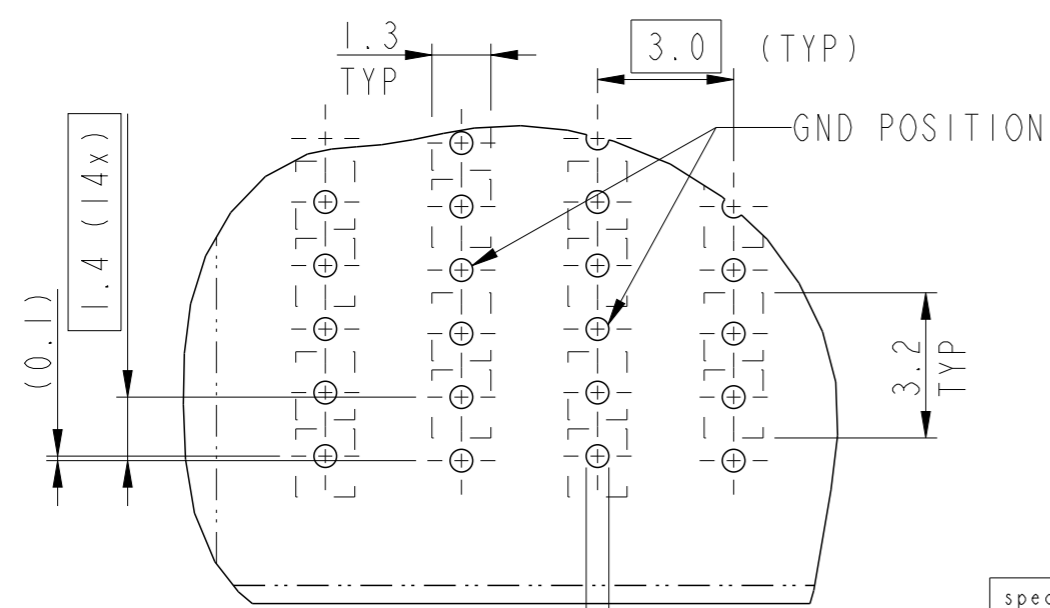

DETAIL B
SCALE 6:1

SEE NOTE 6

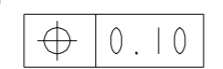

ALL HOLES

spec ref	dr	Louis Ng	2008/05/08	projection	MM	size	A3	scale	1:1
tolerance std	eng	Matthew Cheong	2012/04/04			ecn no	ELX-S-011204-1		
ISO 406	chr	-	rel level				Released		
ISO 1101	appr	Chen-Hong Tan	2012/04/09	product family	AirMax				
surface	linear	0.X	±		title VHdr 5Pr, 10 IMLA, 3mm AirMax Vs Mezzanine	dwg no 10059957	rev D		
		0.XX	±						
		0.XXX	±						
	angular	0°	±°	www.fci.com	cat. no.	-	Product - Customer Drw		sheet 3 of 4

NOMINAL OUTLINE OF CONNECTOR

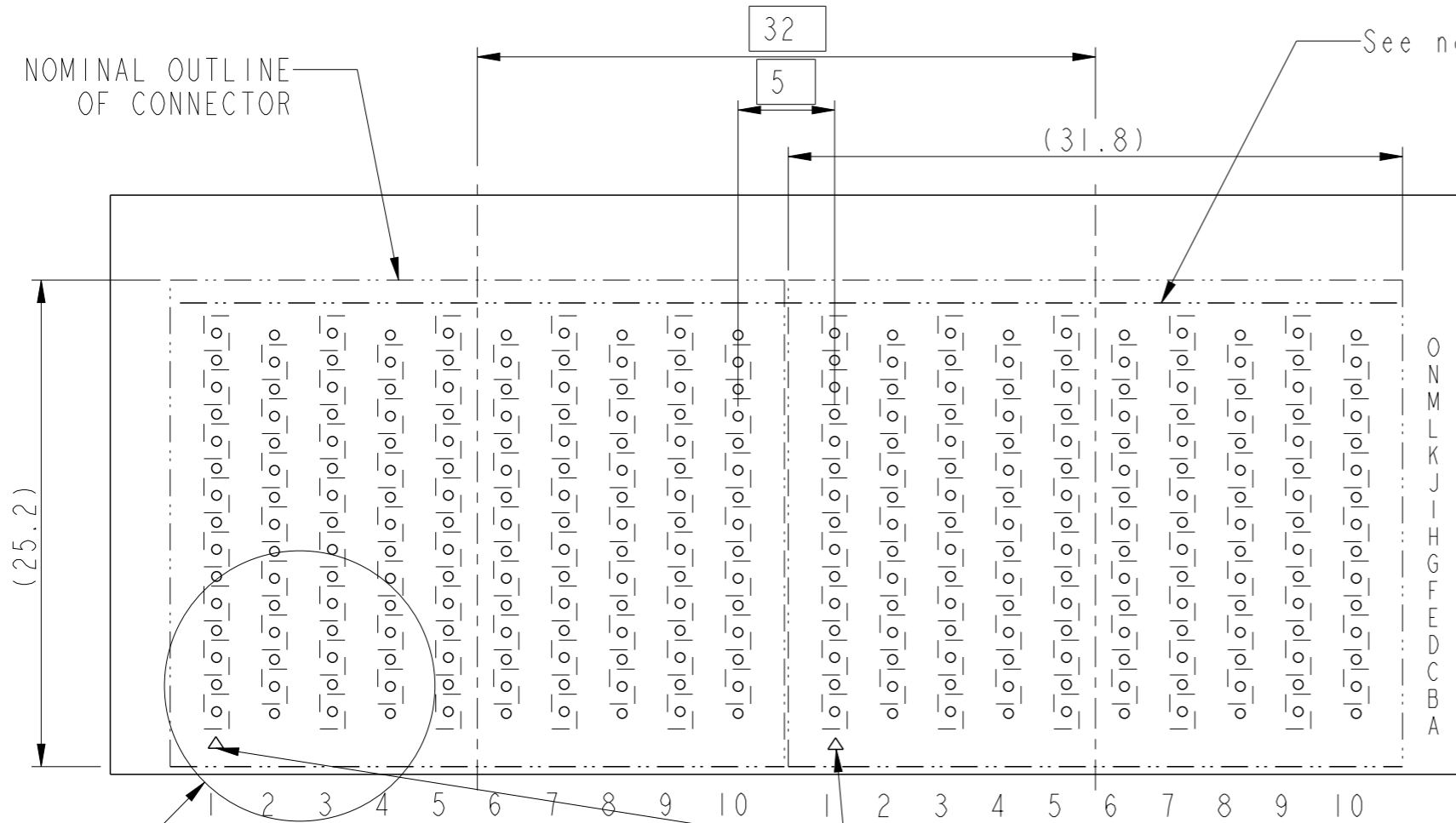

NOTES:

- Connector materials:
Housing: High temp thermoplastic, natural, UL94-V0
Protection cover: High temp thermoplastic, black, UL94-V0
Overmold plastic: High temp thermoplastic, black, UL94-V0
Contact: Copper alloy
- Contact plating:
Seperate Interface: Performance-based plating, qualified to meet the requirements of FCI product specification GS-12-239, including telcordia GR-1217-CORE (November 1995) central office.
Press-fit tails: Pure tin over nickel.
- Product specification: GS-12-379
- Application specification: GS-20-069
Flat rock insertion into PCB by pushing on top of surface protection cover.
- Product marking (Partnumber, lotcode).
- See customer drawing 10045979 for information on PCB hole.
- Lead free partnumbers meet the European Union Directive and other country regulations as described in GS 22-008.
- The housing should withstand exposure to 260° peak temperature for 40 seconds in a convection, reflow or vapour phase reflow oven.
- Packaging specification GS-14-1087 meets GS-14-920 lead free labeling specification.
- Cut-out of connector at opposite side of position A1 indicator. It is recommended to print this visible line on the PCB to indicate proper orientation. Other visible polarisation marks are A1 indicator and printing side.
- Gripping feature to remove protection cover by standard pliers.
- Gripping feature to remove protection cover by fingers.
- A \triangle symbol will be next to any note, dimension or view which has been modified with the current drawing revision.

RECOMMENDED PCB LAYOUT HEADER FOR SINGLE ENDED APPLICATIONS COMPONENT SIDE (TWO ADJACENT FOOTPRINTS SHOWN)

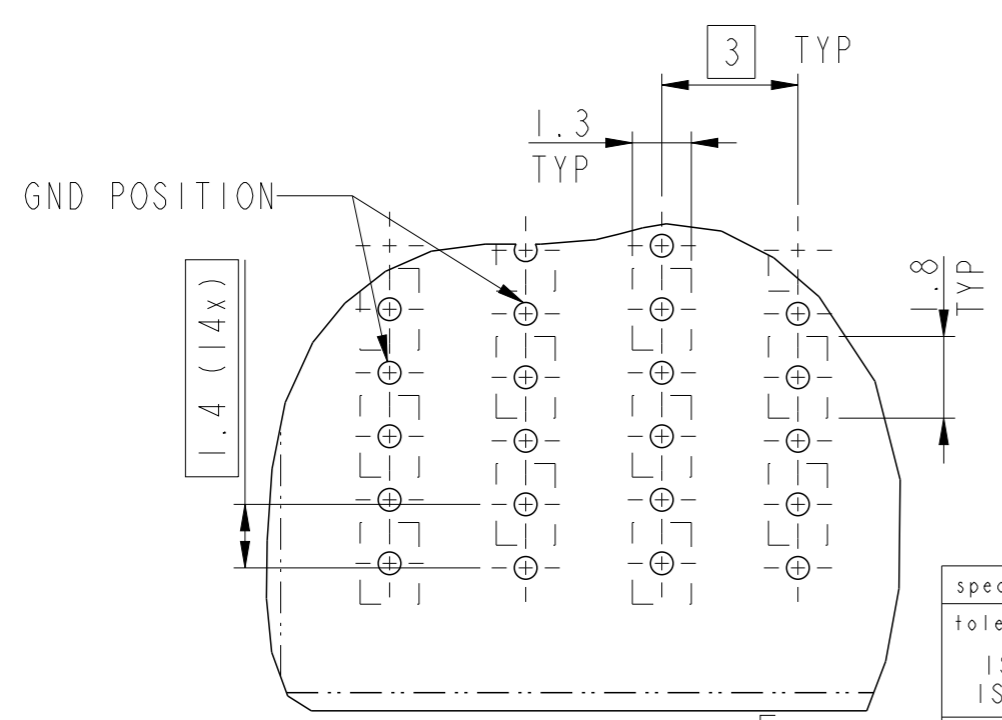

DETAIL F SCALE 6:1

spec ref	dr	Louis Ng	2008/05/08	projection	MM	size	A3	scale	1:1
tolerance std	eng	Matthew Cheong	2012/04/04			ecn no	ELX-S-011204-1	rel level	Released
ISO 406 ISO 1101	chr	-	-						
surface \checkmark	appr	Chen-Hong Tan	2012/04/09	product family		AirMax		rev	
	linear	0.X	\pm	title		VHdr 5Pr, 10 IMLA, 3mm		dwg no	
	angular	0°	\pm	www.fci.com		cat. no.		-	
				Product - Customer Drw		sheet 4 of 4			

Copyright FCI.