

THIS DOCUMENT IS THE PROPERTY OF  
KEYSTONE ELECTRONICS CORP. AND  
SHALL NOT BE REPRODUCED, DISTRIBUTED  
OR USED AS A BASIS FOR MANUFACTURE  
WITHOUT PRIOR WRITTEN PERMISSION  
FROM KEYSTONE ELECTRONICS CORP.

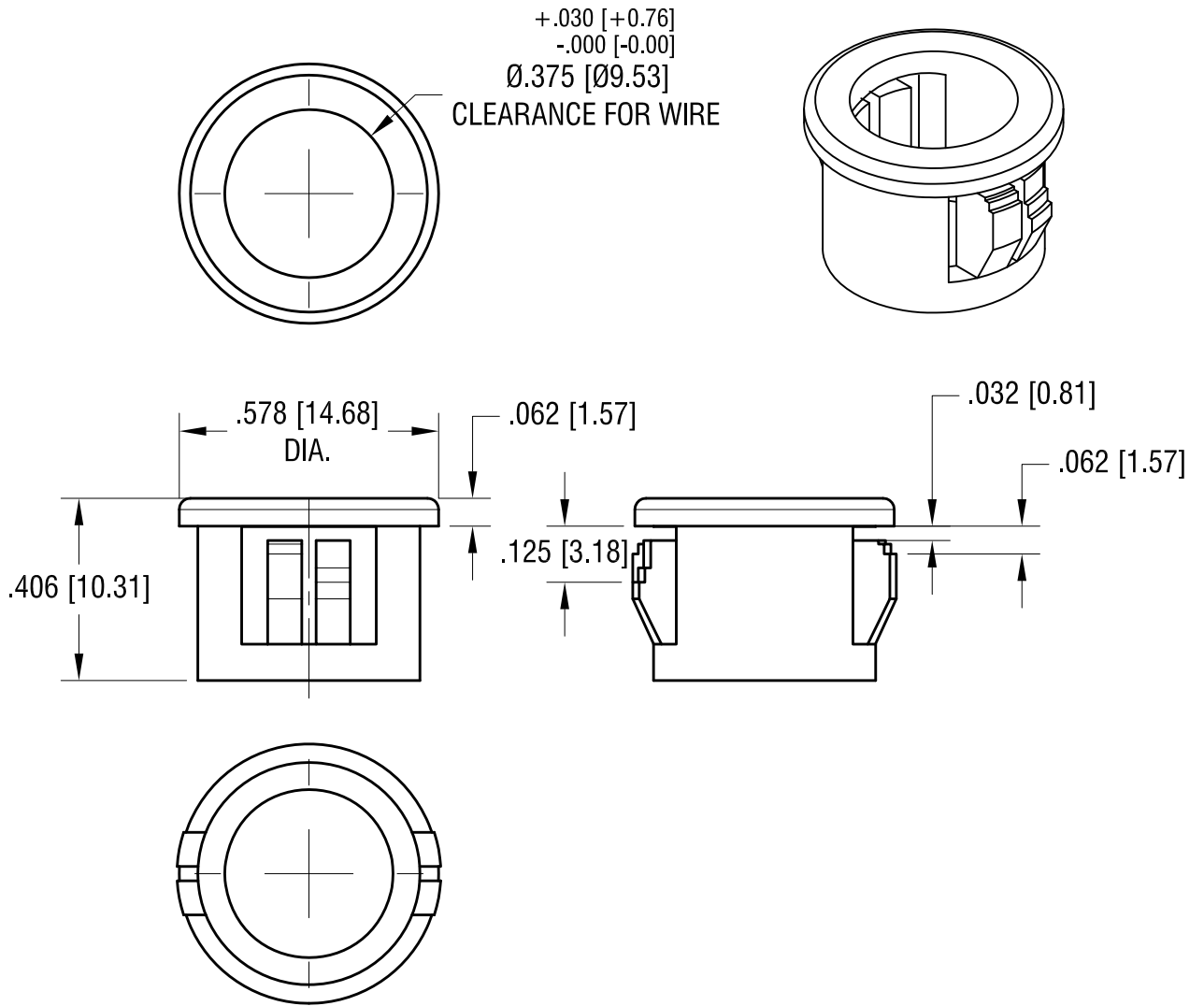

4.21.11	CHANGE AS PER ECR 11-056	A
DATE	DESCRIPTION	REV.

<b>KEYSTONE ELECTRONICS CORP.</b>			
www.keyelco.com • ASTORIA, N.Y. 11105-2017 • Tel (718) 956-8900			
PART NAME			
NYLON INSULATING BUSHING			
MATERIAL			
NYLON 6/6, BLACK UL 94V-2			
FINISH		DRN BY	DATE
-		BOONE	11.22.06
		APP'D	SCALE
		LN	3X
TOLERANCES	INCH [MM]	CODE	DWG NO.
DECIMAL	± .015 [± 0.38]	C/M	<b>8474</b>
ANGULAR	± 1°		
UNLESS OTHERWISE SPECIFIED			