

Product Summary

Device	BV _{DSS}	R _{DS(ON)} Max	I _D Max T _A = +25°C (Notes 7 & 9)
Q1	40V	45mΩ @ V _{GS} = 10V	5.8A
		60mΩ @ V _{GS} = 4.5V	4.2A
Q2	-40V	45mΩ @ V _{GS} = -10V	-5.8A
		60mΩ @ V _{GS} = -4.5V	-4.2A

Description and Applications

This MOSFET is designed to meet the stringent requirements of Automotive applications. It is qualified to AEC-Q101, supported by a PPAP and is ideal for use in:

- 3-Phase BLDC Motor
- CCFL Backlighting

Features and Benefits

- Matched N & P R_{DS(ON)} – Minimizes Power Losses
- Fast Switching – Minimizes Switching Losses
- Dual Device – Reduces PCB Area
- **Totally Lead-Free & Fully RoHS Compliant (Notes 1 & 2)**
- **Halogen and Antimony Free. “Green” Device (Note 3)**
- **Qualified to AEC-Q101 Standards for High Reliability PPAP Capable (Note 4)**

Mechanical Data

- Case: SO-8
- Case Material: Molded Plastic, “Green” Molding Compound. UL Flammability Classification Rating 94V-0
- Moisture Sensitivity: Level 1 per J-STD-020
- Terminals: Finish – Matte Tin Annealed over Copper Leadframe. Solderable per MIL-STD-202, Method 208 (e3)
- Weight: 0.074 grams (Approximate)

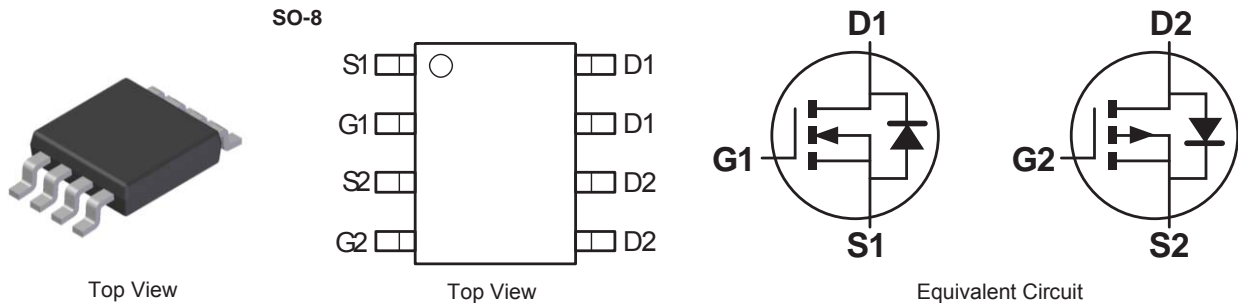

Ordering Information (Note 5)

Part Number	Case	Packaging
DMC4050SSDQ-13	SO-8	2,500/Tape & Reel

- Notes:
1. No purposely added lead. Fully EU Directive 2002/95/EC (RoHS) & 2011/65/EU (RoHS 2) compliant.
 2. See http://www.diodes.com/quality/lead_free.html for more information about Diodes Incorporated's definitions of Halogen- and Antimony-free, "Green" and Lead-free.
 3. Halogen- and Antimony-free "Green" products are defined as those which contain <900ppm bromine, <900ppm chlorine (<1500ppm total Br + Cl) and <1000ppm antimony compounds.
 4. Automotive products are AEC-Q101 qualified and are PPAP capable. Refer to http://www.diodes.com/quality/product_compliance_definitions/.
 5. For packaging details, go to our website at <http://www.diodes.com/products/packages.html>.

Marking Information

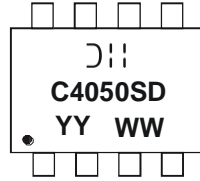

D I = Manufacturer's Marking
 C4050SD = Product Type Marking Code
 YYWW = Date Code Marking
 YY or YY = Year (ex: 16 = 2016)
 WW = Week (01 - 53)

Maximum Ratings (@T_A = +25°C, unless otherwise specified.)

Characteristic		Symbol	N-Channel - Q1	P-Channel - Q2	Units
Drain-Source Voltage		V _{DSS}	40	-40	V
Gate-Source Voltage		V _{GSS}	±20	±20	
Continuous Drain Current	V _{GS} = 10V	(Notes 7 & 9)	5.8	-5.8	A
		T _A = +70°C (Notes 7 & 9)	4.38	-4.52	
		(Notes 6 & 9)	4.2	-4.2	
		(Notes 6 & 10)	5.3	-5.3	
Pulsed Drain Current	V _{GS} = 10V	I _{DM}	24.1	-24.9	
Continuous Source Current (Body Diode)		I _S	2.5	-2.5	
Pulsed Source Current (Body Diode)		I _{SM}	24.1	-24.9	

Thermal Characteristics

Characteristic		Symbol	N-Channel - Q1	P-Channel - Q2	Unit
Power Dissipation Linear Derating Factor	(Notes 6 & 9)	P _D	1.25	10	W
	(Notes 6 & 10)		1.8	14.3	
	(Notes 7 & 9)		2.14	17.2	
Thermal Resistance, Junction to Ambient	(Notes 6 & 9)	R _{θJA}	100		°C/W
	(Notes 6 & 10)		70		
	(Notes 7 & 9)		58		
Thermal Resistance, Junction to Lead		R _{θJL}	51		°C
Operating and Storage Temperature Range		T _J , T _{STG}	-55 to +150		

- Notes:
- For a device surface mounted on 25mm x 25mm x 1.6mm FR4 PCB with high coverage of single sided 1oz copper, in still air conditions; the device is measured when operating in a steady-state condition.
 - Same as Note (6), except the device is measured at t ≤ 10 sec.
 - Same as Note (6), except the device is pulsed with D = 0.02 and pulse width 300μs.
 - For a dual device with one active die.
 - For a device with two active die running at equal power.
 - Thermal resistance from junction to solder-point (at the end of the drain lead).

Thermal Characteristics (Continued)

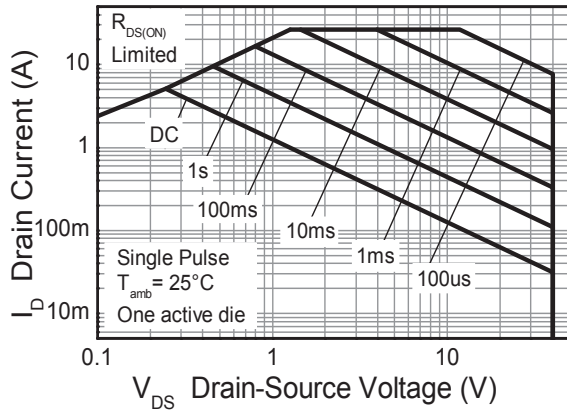

N-channel Safe Operating Area

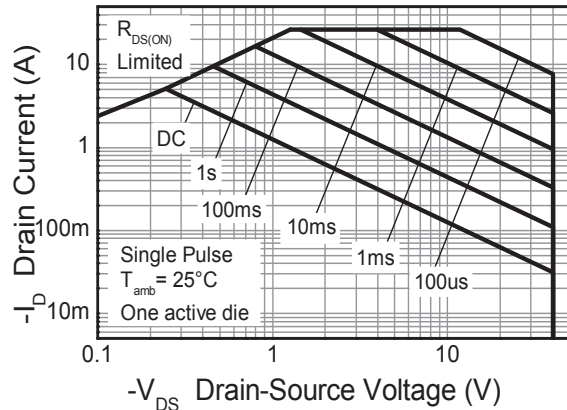

P-channel Safe Operating Area

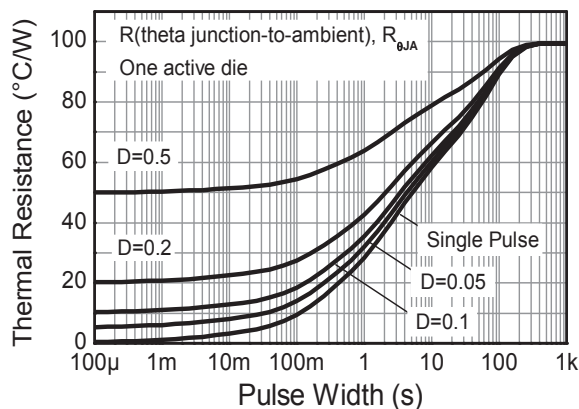

Transient Thermal Impedance

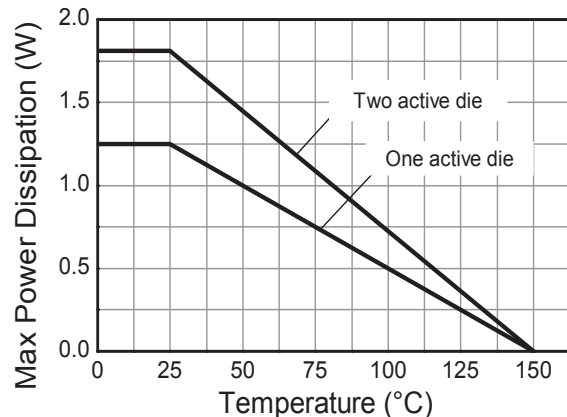

Derating Curve

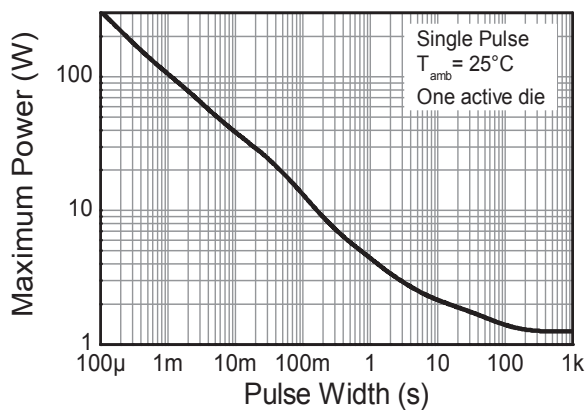

Pulse Power Dissipation

Electrical Characteristics (Q1 N-Channel) (@T_A = +25°C, unless otherwise specified.)

Characteristic	Symbol	Min	Typ	Max	Unit	Test Condition
OFF CHARACTERISTICS (Note 12)						
Drain-Source Breakdown Voltage	BV _{DSS}	40	—	—	V	V _{GS} = 0V, I _D = 250μA
Zero Gate Voltage Drain Current T _J = +25°C	I _{DSS}	—	—	1.0	μA	V _{DS} = 40V, V _{GS} = 0V
Gate-Source Leakage	I _{GSS}	—	—	±100	nA	V _{GS} = ±20V, V _{DS} = 0V
ON CHARACTERISTICS (Note 12)						
Gate Threshold Voltage	V _{GS(TH)}	0.8	1.3	1.8	V	V _{DS} = V _{GS} , I _D = 250μA
Static Drain-Source On-Resistance	R _{DS(ON)}	—	20	45	mΩ	V _{GS} = 10V, I _D = 3A
			33	60		V _{GS} = 4.5V, I _D = 3A
Forward Transfer Admittance	Y _{FS}	—	12.6	—	S	V _{DS} = 5V, I _D = 3A
Diode Forward Voltage (Note 12)	V _{SD}	—	0.7	1.0	V	V _{GS} = 0V, I _S = 1A
DYNAMIC CHARACTERISTICS (Note 13)						
Input Capacitance	C _{ISS}	—	1,790.8	—	pF	V _{DS} = 20V, V _{GS} = 0V, f = 1.0MHz
Output Capacitance	C _{OSS}	—	160.6	—	pF	
Reverse Transfer Capacitance	C _{RSS}	—	120.5	—	pF	
Gate Resistance	R _G	—	1.03	—	Ω	V _{DS} = 0V, V _{GS} = 0V, f = 1MHz
Total Gate Charge	Q _G	—	37.56	—	nC	V _{GS} = 10V, V _{DS} = 20V, I _D = 3A
Gate-Source Charge	Q _{GS}	—	7.8	—	nC	
Gate-Drain Charge	Q _{GD}	—	6.6	—	nC	
Turn-On Delay Time	t _{D(ON)}	—	8.08	—	ns	V _{GS} = 10V, V _{DS} = 20V, I _D = 3A
Turn-On Rise Time	t _R	—	15.14	—	ns	
Turn-Off Delay Time	t _{D(OFF)}	—	24.29	—	ns	
Turn-Off Fall Time	t _F	—	5.27	—	ns	

Electrical Characteristics (Q2 P-Channel) (@T_A = +25°C, unless otherwise specified.)

Characteristic	Symbol	Min	Typ	Max	Unit	Test Condition
OFF CHARACTERISTICS (Note 12)						
Drain-Source Breakdown Voltage	BV _{DSS}	-40	—	—	V	V _{GS} = 0V, I _D = -250μA
Zero Gate Voltage Drain Current T _J = +25°C	I _{DSS}	—	—	-1.0	μA	V _{DS} = -40V, V _{GS} = 0V
Gate-Source Leakage	I _{GSS}	—	—	±100	nA	V _{GS} = ±20V, V _{DS} = 0V
ON CHARACTERISTICS (Note 12)						
Gate Threshold Voltage	V _{GS(TH)}	-0.8	-1.3	-1.8	V	V _{DS} = V _{GS} , I _D = -250μA
Static Drain-Source On-Resistance	R _{DS(ON)}	—	28	45	mΩ	V _{GS} = -10V, I _D = -3A
			30	60		V _{GS} = -4.5V, I _D = -3A
Forward Transfer Admittance	Y _{FS}	—	16.6	—	S	V _{DS} = -5V, I _D = -3A
Diode Forward Voltage (Note 12)	V _{SD}	—	-0.7	-1.0	V	V _{GS} = 0V, I _S = -1A
DYNAMIC CHARACTERISTICS (Note 13)						
Input Capacitance	C _{ISS}	—	1,643.17	—	pF	V _{DS} = -20V, V _{GS} = 0V, f = 1.0MHz
Output Capacitance	C _{OSS}	—	179.13	—	pF	
Reverse Transfer Capacitance	C _{RSS}	—	127.82	—	pF	
Gate Resistance	R _G	—	6.43	—	Ω	V _{DS} = 0V, V _{GS} = 0V, f = 1MHz
Total Gate Charge	Q _G	—	33.66	—	nC	V _{GS} = -10V, V _{DS} = -20V, I _D = -3A
Gate-Source Charge	Q _{GS}	—	5.54	—	nC	
Gate-Drain Charge	Q _{GD}	—	7.30	—	nC	
Turn-On Delay Time	t _{D(ON)}	—	6.85	—	ns	V _{GS} = -10V, V _{DS} = -20V, I _D = -3A
Turn-On Rise Time	t _R	—	14.72	—	ns	
Turn-Off Delay Time	t _{D(OFF)}	—	53.65	—	ns	
Turn-Off Fall Time	t _F	—	30.86	—	ns	

Notes: 12. Short duration pulse test used to minimize self-heating effect.
13. Guaranteed by design. Not subject to production testing.

Typical Characteristics (Q1 N-Channel)

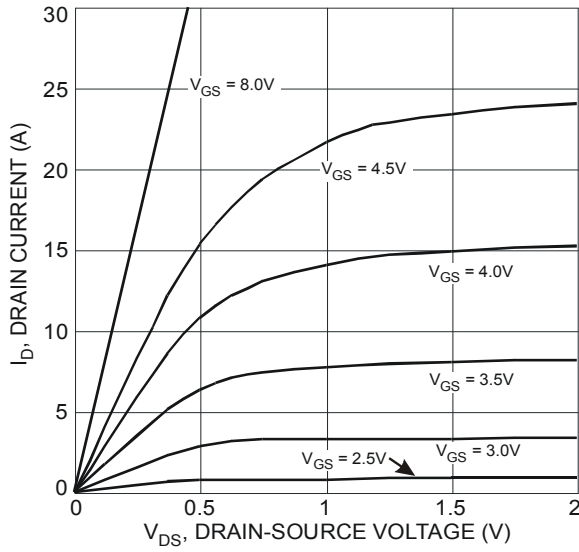

Fig. 1 Typical Output Characteristic

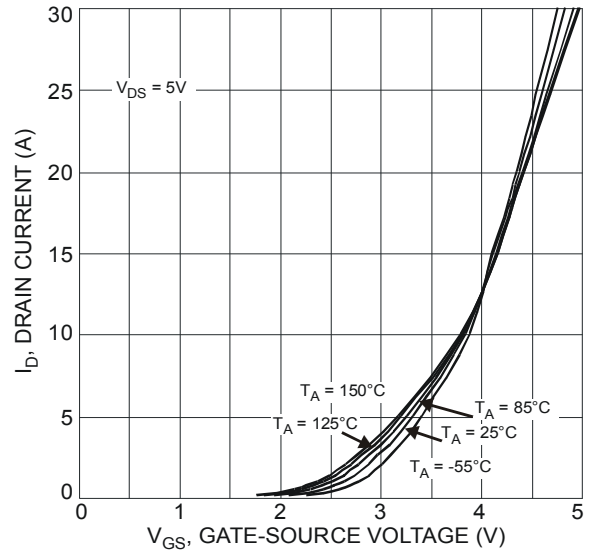

Fig. 2 Typical Transfer Characteristic

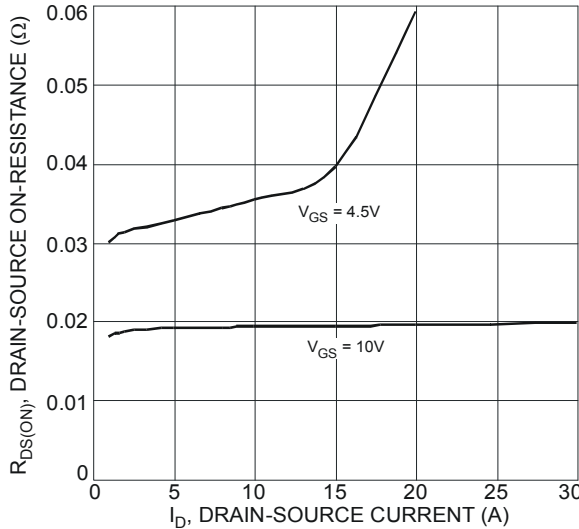

Fig. 3 Typical On-Resistance vs. Drain Current and Gate Voltage

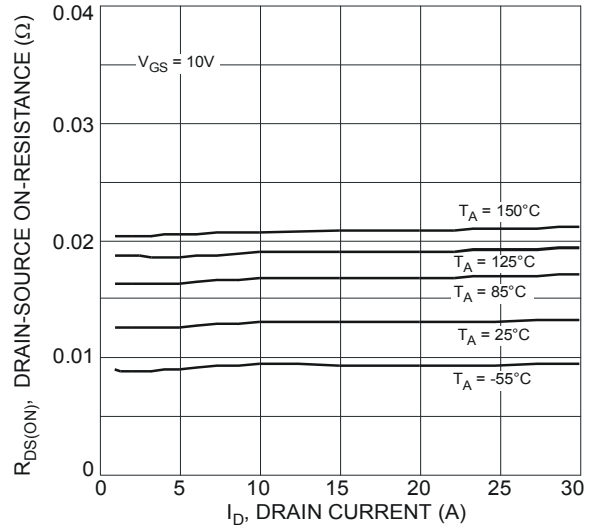

Fig. 4 Typical On-Resistance vs. Drain Current and Temperature

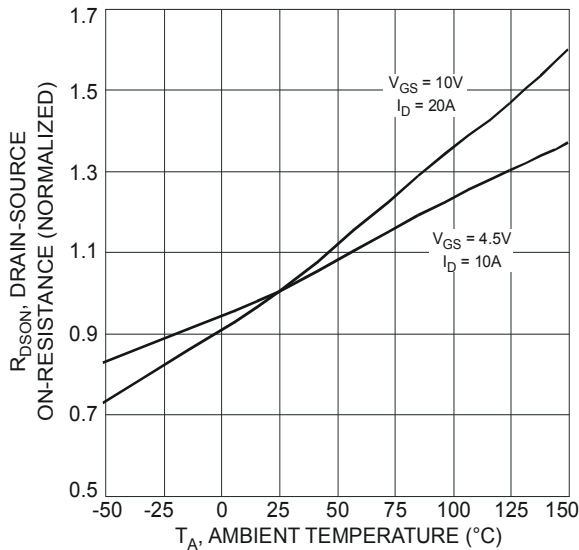

Fig. 5 On-Resistance Variation with Temperature

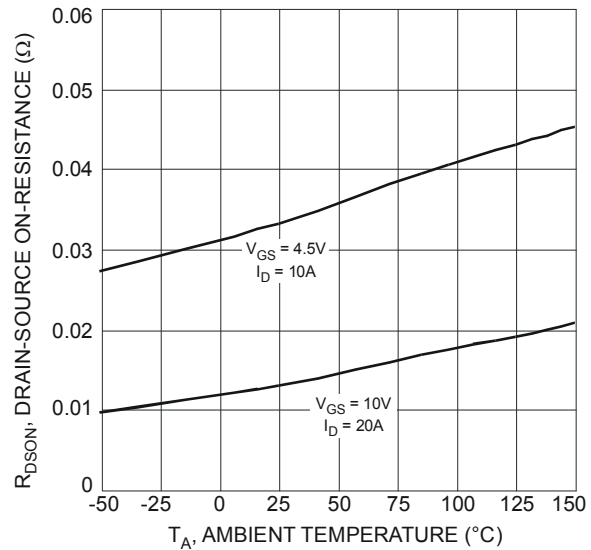

Fig. 6 On-Resistance Variation with Temperature

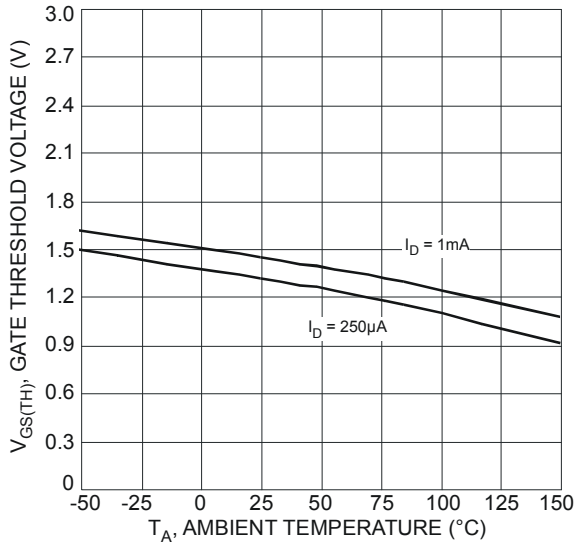

Fig. 7 Gate Threshold Variation vs. Ambient Temperature

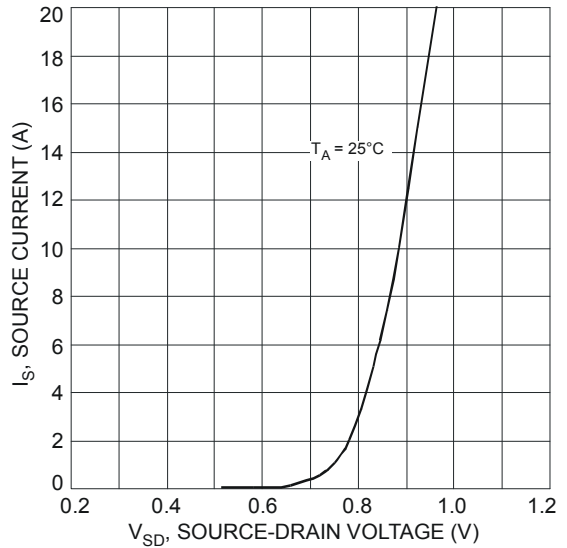

Fig. 8 Diode Forward Voltage vs. Current

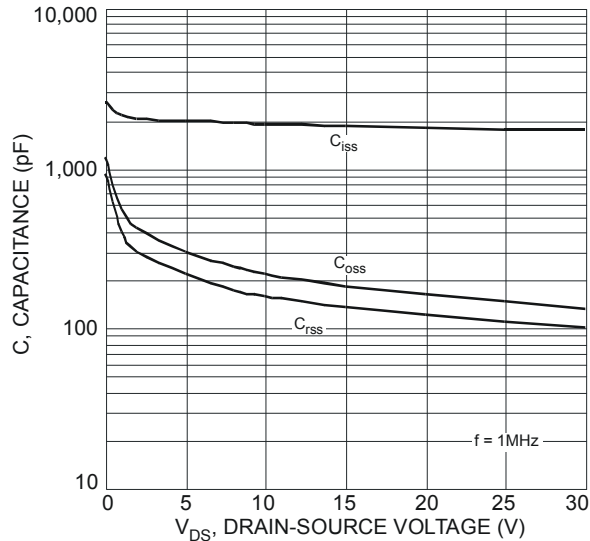

Fig. 9 Typical Total Capacitance

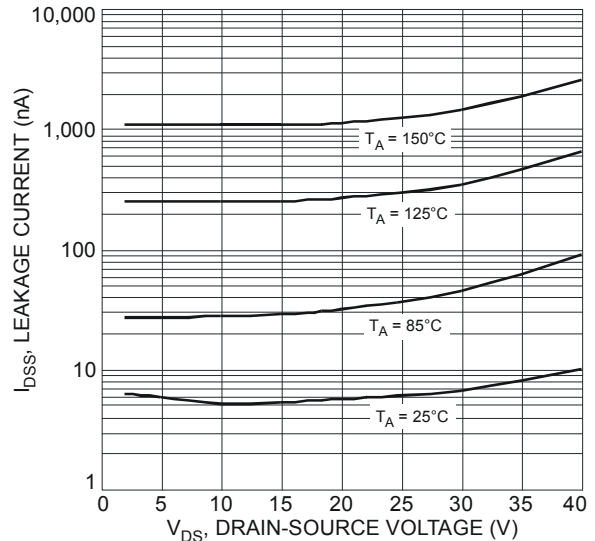

Fig. 10 Typical Leakage Current vs. Drain-Source Voltage

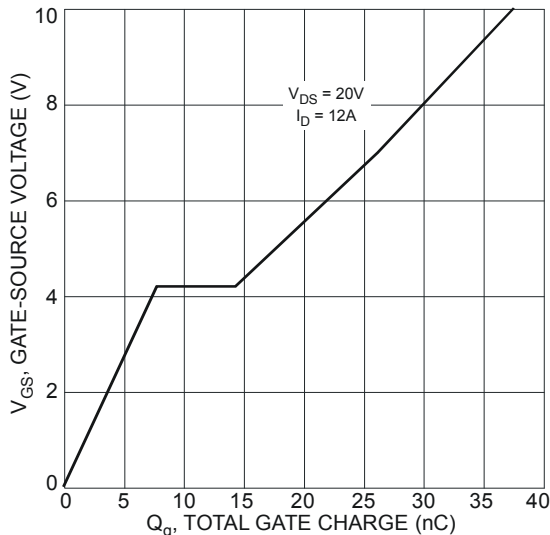

Fig. 11 Gate-Charge Characteristics

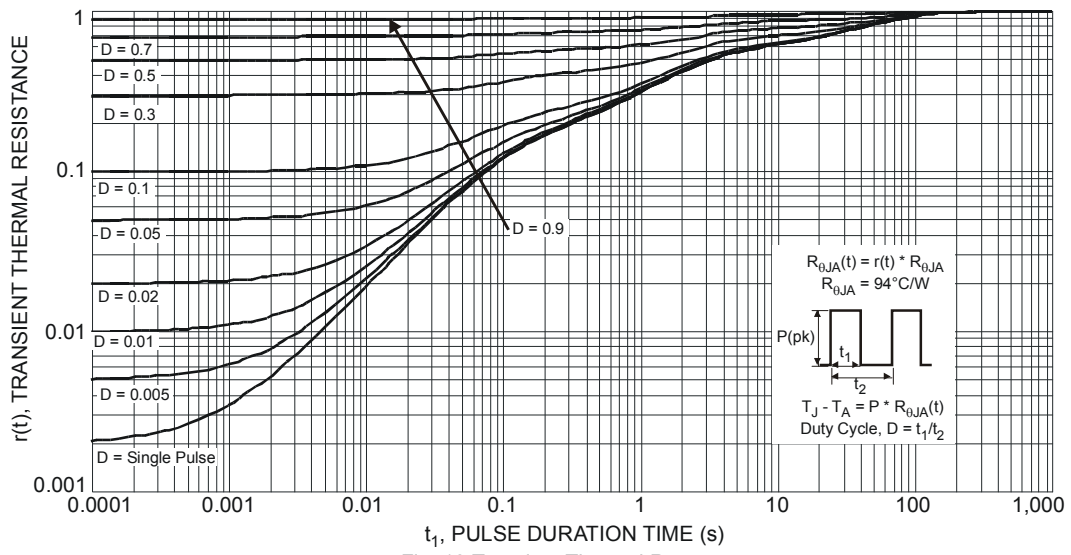

Fig. 12 Transient Thermal Response

Typical Characteristics (Q2 P-Channel)

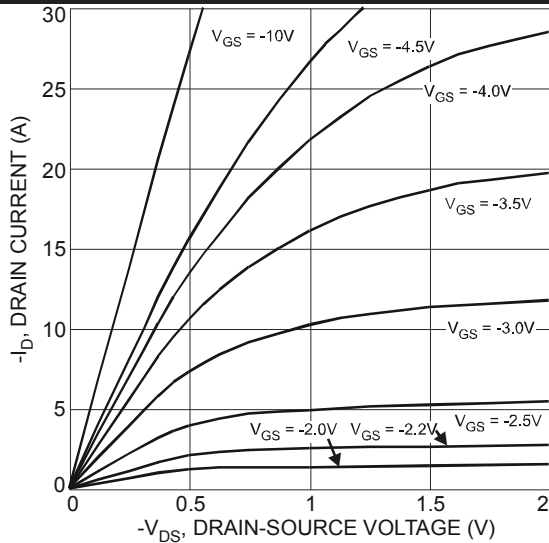

Fig. 13 Typical Output Characteristic

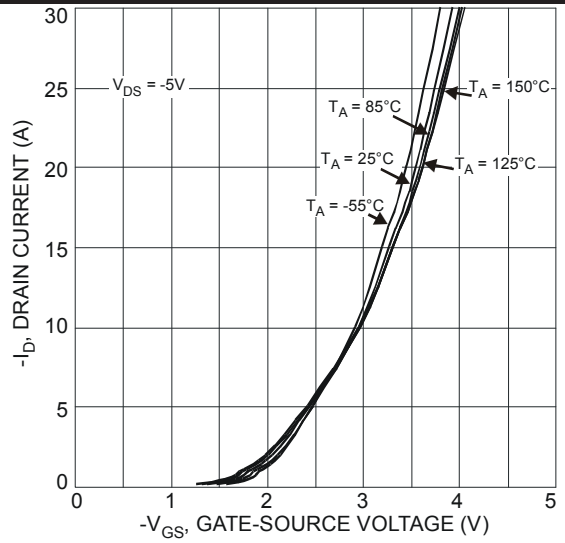

Fig. 14 Typical Transfer Characteristic

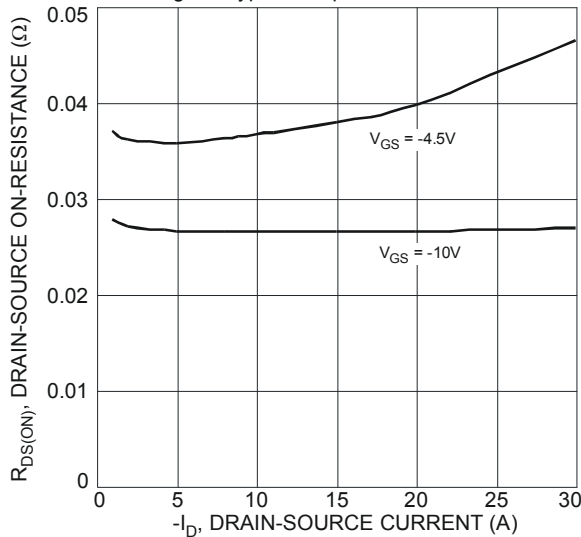

Fig. 15 Typical On-Resistance vs. Drain Current and Gate Voltage

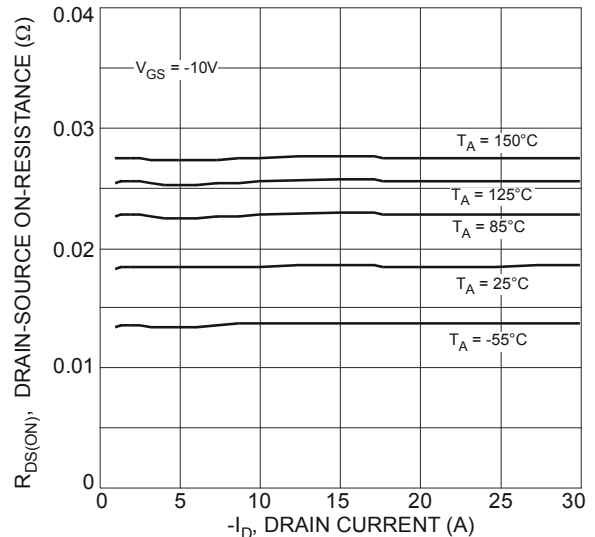

Fig. 16 Typical On-Resistance vs. Drain Current and Temperature

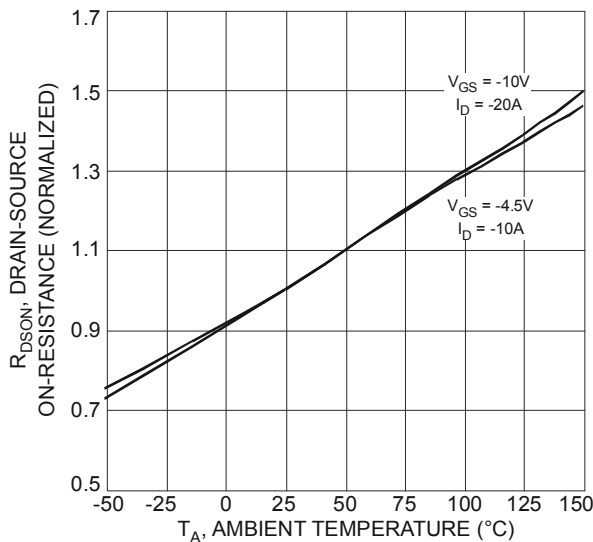

Fig. 17 On-Resistance Variation with Temperature

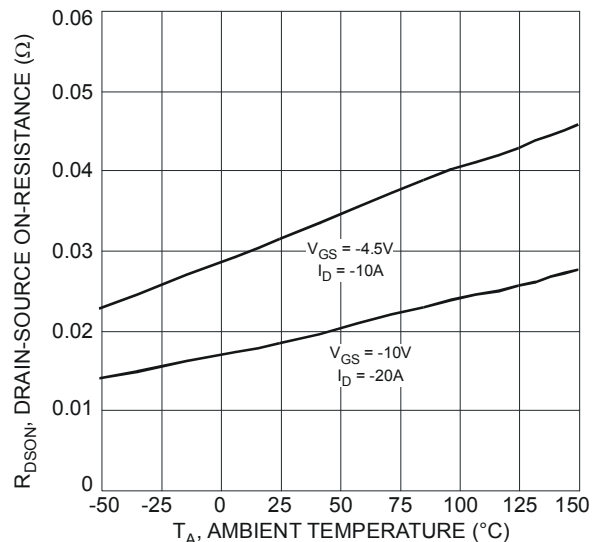

Fig. 18 On-Resistance Variation with Temperature

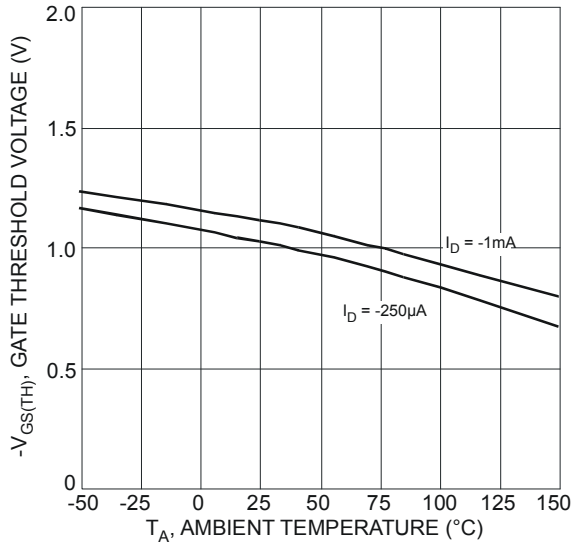

Fig. 19 Gate Threshold Variation vs. Ambient Temperature

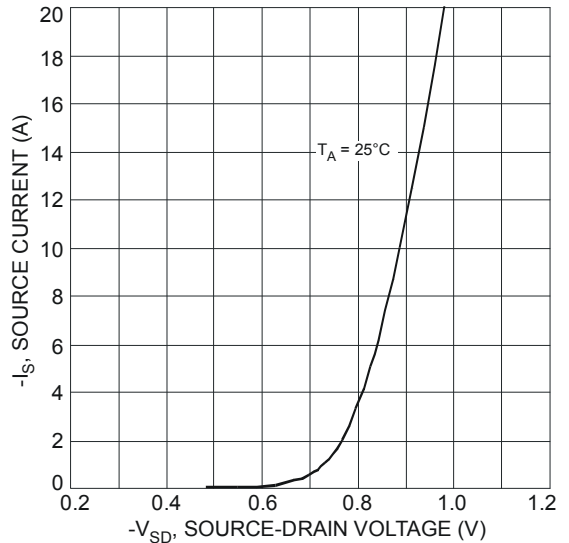

Fig. 20 Diode Forward Voltage vs. Current

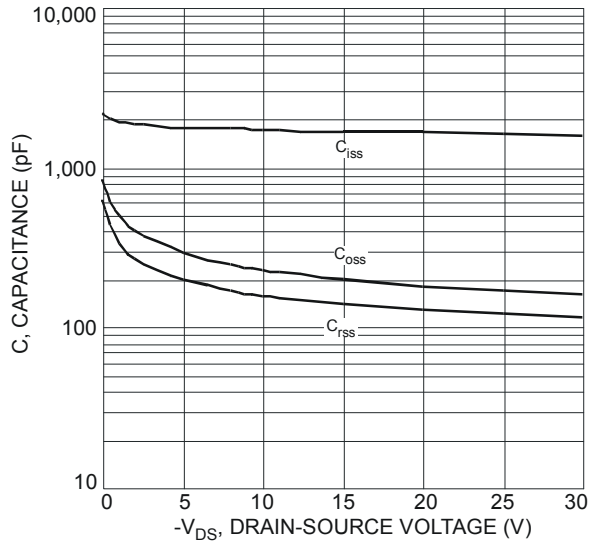

Fig. 21 Typical Total Capacitance

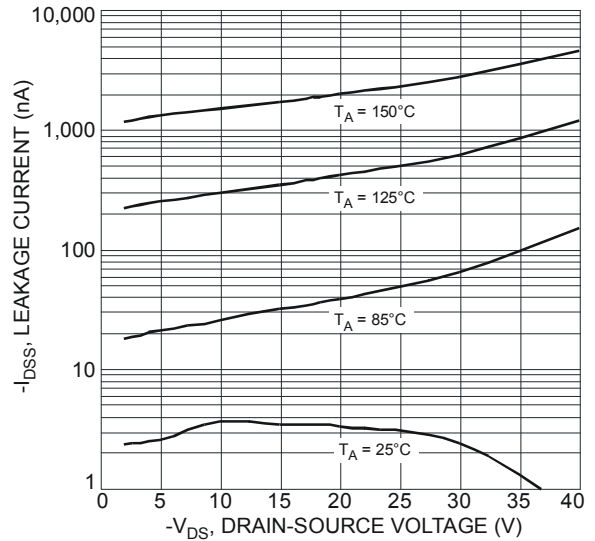

Fig. 22 Typical Leakage Current vs. Drain-Source Voltage

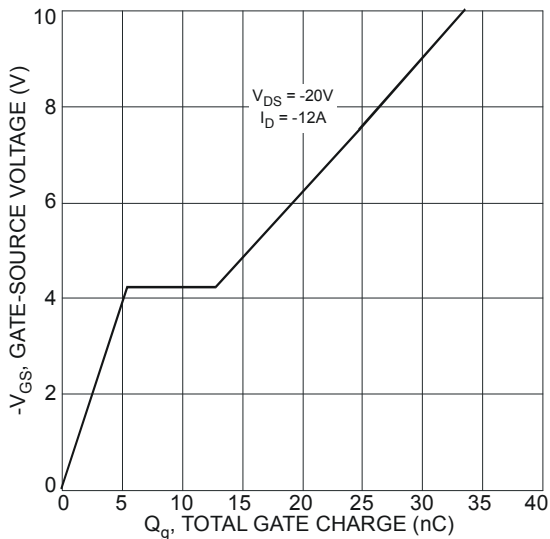

Fig. 23 Gate-Charge Characteristics

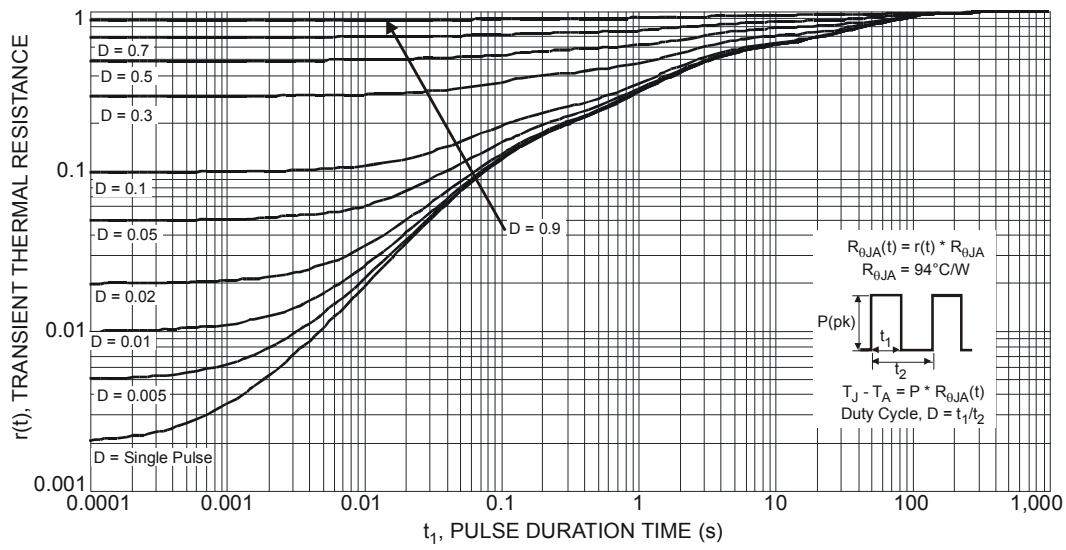
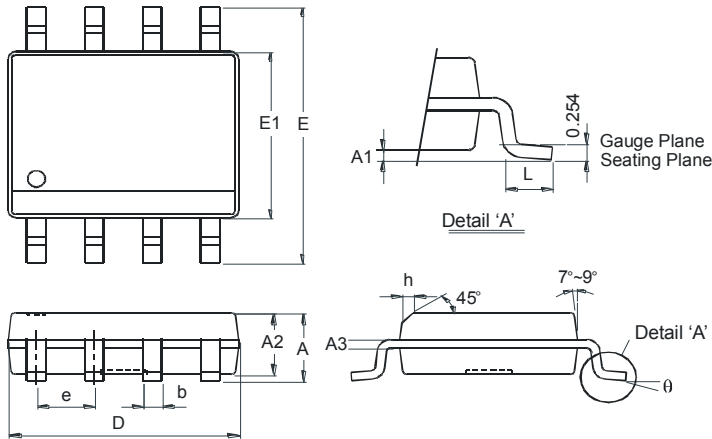

Fig. 24 Transient Thermal Response

Package Outline Dimensions

Please see <http://www.diodes.com/package-outlines.html> for the latest version.

SO-8



SO-8		
Dim	Min	Max
A	-	1.75
A1	0.10	0.20
A2	1.30	1.50
A3	0.15	0.25
b	0.3	0.5
D	4.85	4.95
E	5.90	6.10
E1	3.85	3.95
e	1.27 Typ	
h	-	0.35
L	0.62	0.82
θ	0°	8°
All Dimensions in mm		

Suggested Pad Layout

Please see <http://www.diodes.com/package-outlines.html> for the latest version.

SO-8

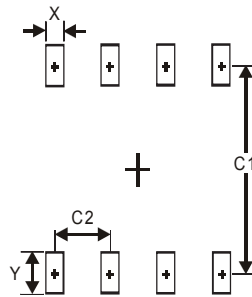

Dimensions	Value (in mm)
X	0.60
Y	1.55
C1	5.4
C2	1.27

IMPORTANT NOTICE

DIODES INCORPORATED MAKES NO WARRANTY OF ANY KIND, EXPRESS OR IMPLIED, WITH REGARDS TO THIS DOCUMENT, INCLUDING, BUT NOT LIMITED TO, THE IMPLIED WARRANTIES OF MERCHANTABILITY AND FITNESS FOR A PARTICULAR PURPOSE (AND THEIR EQUIVALENTS UNDER THE LAWS OF ANY JURISDICTION).

Diodes Incorporated and its subsidiaries reserve the right to make modifications, enhancements, improvements, corrections or other changes without further notice to this document and any product described herein. Diodes Incorporated does not assume any liability arising out of the application or use of this document or any product described herein; neither does Diodes Incorporated convey any license under its patent or trademark rights, nor the rights of others. Any Customer or user of this document or products described herein in such applications shall assume all risks of such use and will agree to hold Diodes Incorporated and all the companies whose products are represented on Diodes Incorporated website, harmless against all damages.

Diodes Incorporated does not warrant or accept any liability whatsoever in respect of any products purchased through unauthorized sales channel. Should Customers purchase or use Diodes Incorporated products for any unintended or unauthorized application, Customers shall indemnify and hold Diodes Incorporated and its representatives harmless against all claims, damages, expenses, and attorney fees arising out of, directly or indirectly, any claim of personal injury or death associated with such unintended or unauthorized application.

Products described herein may be covered by one or more United States, international or foreign patents pending. Product names and markings noted herein may also be covered by one or more United States, international or foreign trademarks.

This document is written in English but may be translated into multiple languages for reference. Only the English version of this document is the final and determinative format released by Diodes Incorporated.

LIFE SUPPORT

Diodes Incorporated products are specifically not authorized for use as critical components in life support devices or systems without the express written approval of the Chief Executive Officer of Diodes Incorporated. As used herein:

A. Life support devices or systems are devices or systems which:

1. are intended to implant into the body, or
2. support or sustain life and whose failure to perform when properly used in accordance with instructions for use provided in the labeling can be reasonably expected to result in significant injury to the user.

B. A critical component is any component in a life support device or system whose failure to perform can be reasonably expected to cause the failure of the life support device or to affect its safety or effectiveness.

Customers represent that they have all necessary expertise in the safety and regulatory ramifications of their life support devices or systems, and acknowledge and agree that they are solely responsible for all legal, regulatory and safety-related requirements concerning their products and any use of Diodes Incorporated products in such safety-critical, life support devices or systems, notwithstanding any devices- or systems-related information or support that may be provided by Diodes Incorporated. Further, Customers must fully indemnify Diodes Incorporated and its representatives against any damages arising out of the use of Diodes Incorporated products in such safety-critical, life support devices or systems.

Copyright © 2016, Diodes Incorporated

www.diodes.com