

# Vibration Meter

805



## Measurement Tips

### LED Status

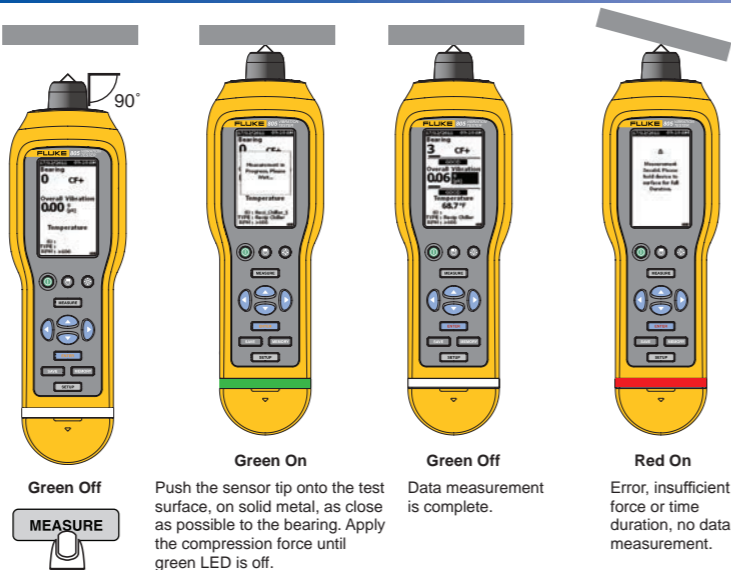

### Sensor Placement

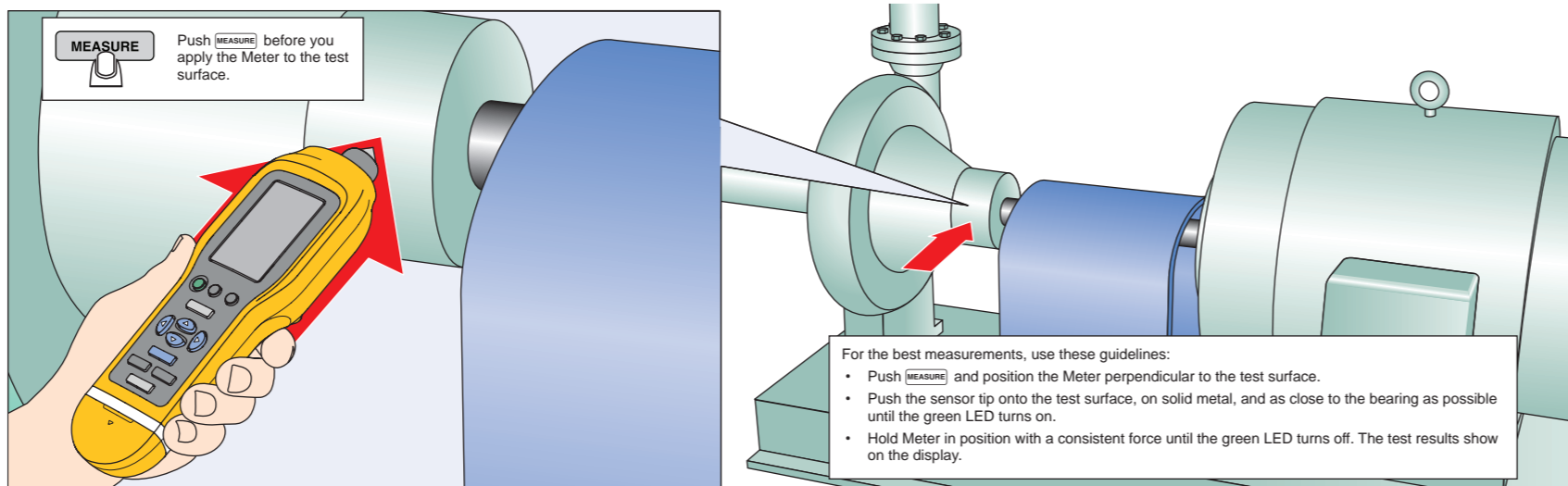

## Vibration Severity Per ISO 10816-1

Machine	Machine		Class I Small Machines	Class II Medium Machines	Class II Large Rigid Foundation	Class III Large Soft Foundation
	in/s	mm/s				
Vibration Velocity Vrms	0.01	0.28	GOOD	GOOD	GOOD	GOOD
	0.02	0.45				
	0.03	0.71				
	0.04	1.12	SATISFACTORY	SATISFACTORY	GOOD	GOOD
	0.07	1.80				
	0.11	2.80	UNSATISFACTORY	UNSATISFACTORY	UNSATISFACTORY	UNSATISFACTORY
	0.18	4.50				
	0.28	7.10	UNACCEPTABLE	UNACCEPTABLE	UNACCEPTABLE	UNACCEPTABLE
	0.44	11.20				
	0.70	18.00				
1.10	28.00	UNACCEPTABLE	UNACCEPTABLE	UNACCEPTABLE	UNACCEPTABLE	
1.77	45.90					

## Severity Scale

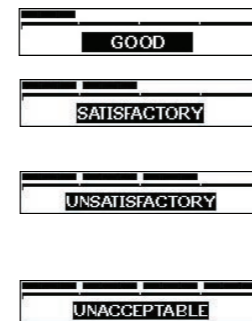

**GOOD:** No repair action is recommended.

**SATISFACTORY:** No immediate repair action is required. Increase the frequency of measurements and monitor the condition of the machine.

**UNSATISFACTORY:** Have a knowledgeable vibration technician conduct more advanced tests at the earliest opportunity. Consider maintenance action at the next planned downtime or maintenance period.

**UNACCEPTABLE:** Have a knowledgeable vibration technician conduct more advanced tests as soon as possible. Consider immediate shutdown of the machine to make repairs and prevent failure.

## Crest Factor + (CF+)

The Meter operates with a proprietary algorithm called Crest Factor + (CF+). To make interpretation easy for the user, the CF+ value is shown in a range from 1 to 16 in the severity scale. The higher the CF+ value is, the more the bearing damage.

The CF+ value shows for every measurement in the Bearing field on the Meter display. Push **[CF+]** and **[CF+]** to toggle between the CF+ value and the high frequency vibration level in units of acceleration.

## Meter Display

17/12/2011 09:10 AM

Bearing Vibration (CF+): **3** **CF+**

Overall Vibration: **GOOD**

Frequency Range: 10 Hz to 1,000 Hz

Overall Vibration: **0.06 g (pk)**

Temperature: **GOOD**

Temperature: **68.7°F**

ID: TYPE: Recip Chiller RPM: >600

## Data Transfer

### Export Data

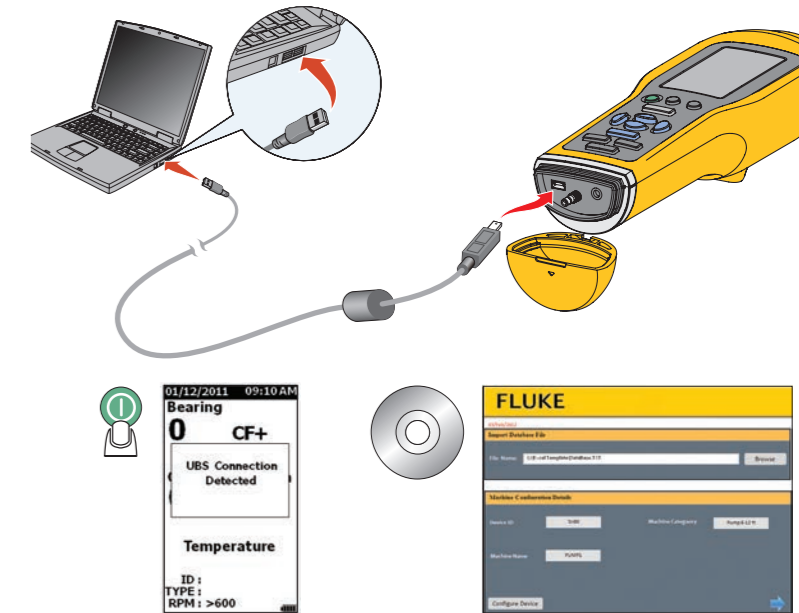

## Trending

The product CD supplies a custom Microsoft Excel template that helps you to evaluate the measurements. See *Export Data* in the Users Manual for more information about the template and measurement plots.

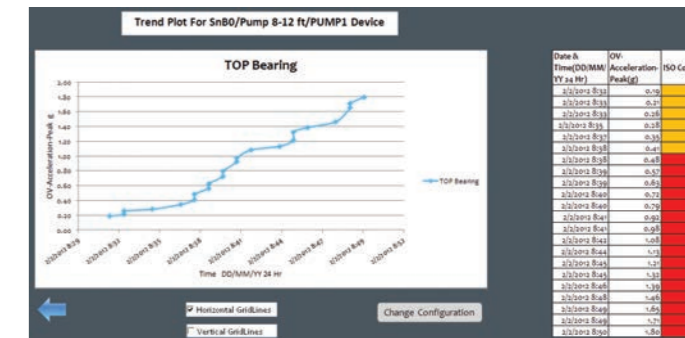

# Safety and Warranty

## Safety



- To prevent possible electrical shock, fire, or personal injury:
- Carefully read all instructions.
  - Do not touch hazardous voltages with the Product. These voltages could cause injury or death.
  - Use the Product only as specified, or the protection supplied by the product can be compromised.
  - Examine the case before you use the Product. Look for cracks or missing plastic.
  - Make sure the battery is securely in position before operation.
  - Do not use the Product around explosive gas, vapor, or in damp or wet environments.
  - Comply with local and national safety codes. Use personal protective equipment (approved rubber gloves, face protection, and flame-resistant clothes) to prevent shock and arc blast injury where hazardous live conductors are exposed.

- To prevent personal injury from the infrared thermometer:
- See emissivity information for actual temperatures. Reflective objects result in lower than actual temperature measurements. These objects pose a burn hazard.
  - Do not keep the product in operation and unattended at high temperatures.
- To prevent personal injury when near rotating equipment:
- Use caution around rotating equipment.
  - Keep cords and straps contained.

## LIMITED WARRANTY AND LIMITATION OF LIABILITY

This Fluke product will be free from defects in material and workmanship for one year from the date of purchase. This warranty does not cover fuses, disposable batteries, or damage from accident, neglect, misuse, alteration, contamination, or abnormal conditions of operation or handling. Resellers are not authorized to extend any other warranty on Fluke's behalf. To obtain service during the warranty period, contact your nearest Fluke authorized service center to obtain return authorization information, then send the product to that Service Center with a description of the problem.

THIS WARRANTY IS YOUR ONLY REMEDY. NO OTHER WARRANTIES, SUCH AS FITNESS FOR A PARTICULAR PURPOSE, ARE EXPRESSED OR IMPLIED. FLUKE IS NOT LIABLE FOR ANY SPECIAL, INDIRECT, INCIDENTAL OR CONSEQUENTIAL DAMAGES OR LOSSES, ARISING FROM ANY CAUSE OR THEORY. Since some states or countries do not allow the exclusion or limitation of an implied warranty or of incidental or consequential damages, this limitation of liability may not apply to you.

Fluke Corporation  
P.O. Box 9090  
Everett, WA 98206-9090  
U.S.A.

Fluke Europe B.V.  
P.O. Box 1186  
5602 BD Eindhoven  
The Netherlands

# Before You Start

## Navigation

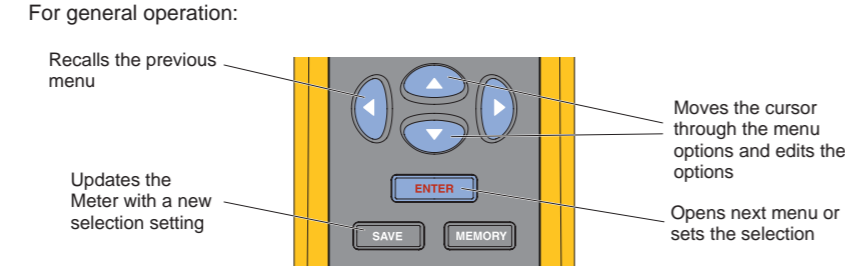

Each menu has navigation hints for its content at the bottom of the screen.

## Battery

Before the Meter operates for the first time, install the two AA alkaline batteries included in shipment. The Meter also operates on two AA rechargeable Li ion (1.5 v) or NiCd / NiMH (1.2 v) batteries.

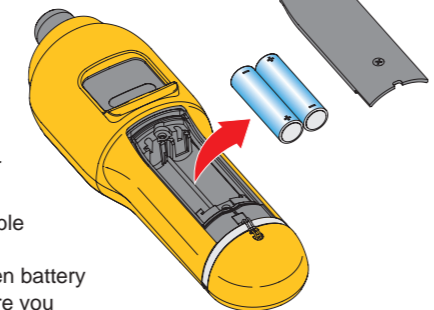

*Note*  
Set the battery type in the Device Settings menu.

The Meter does not include a rechargeable function. You must externally charge the batteries. shows on the display when battery power is low. Replace the batteries before you continue to use the Meter.

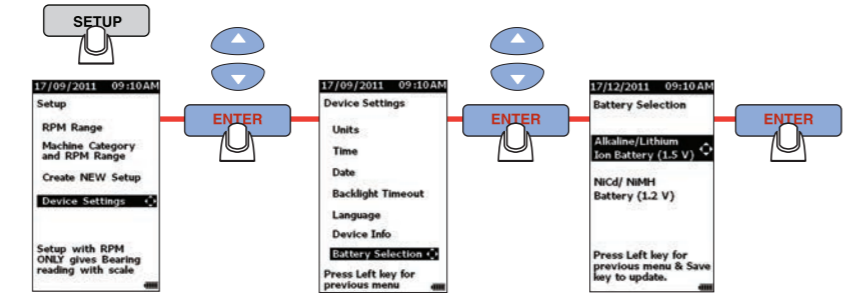

# Meter Configuration

## Setup Menu

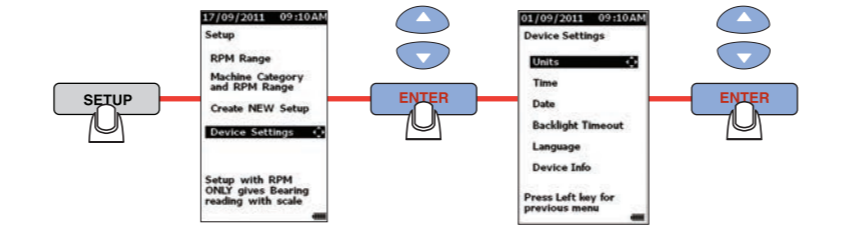

## Units

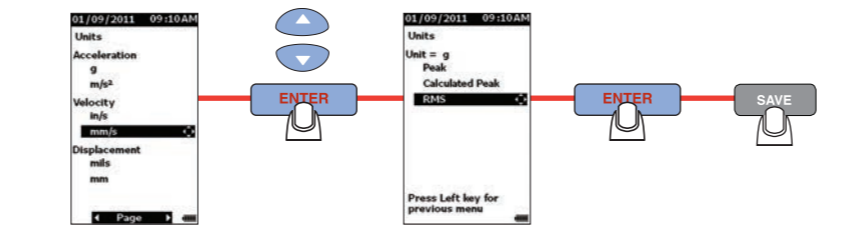

## Time

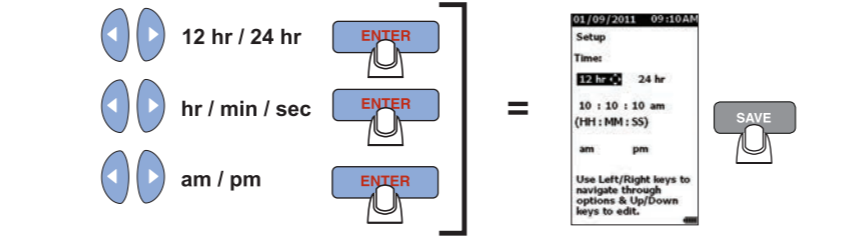

## Date

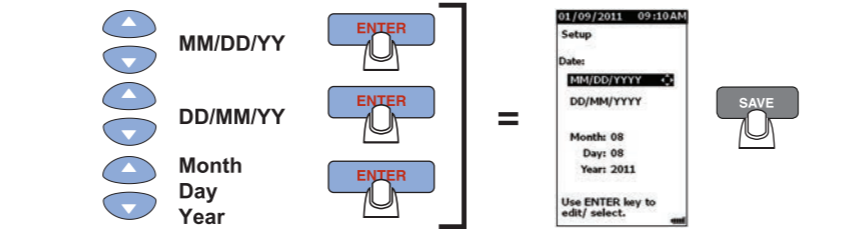

# Measurements

## Quick Measurement

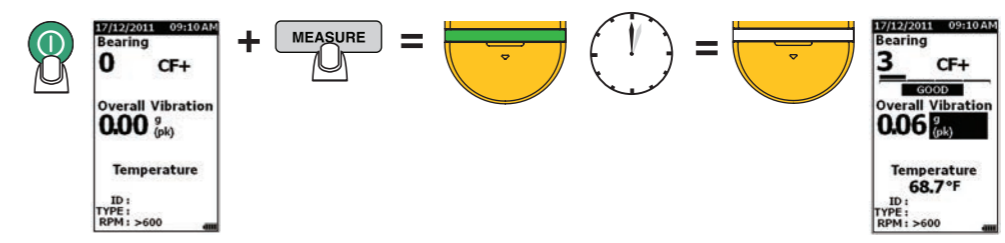

## Auto Save Measurement

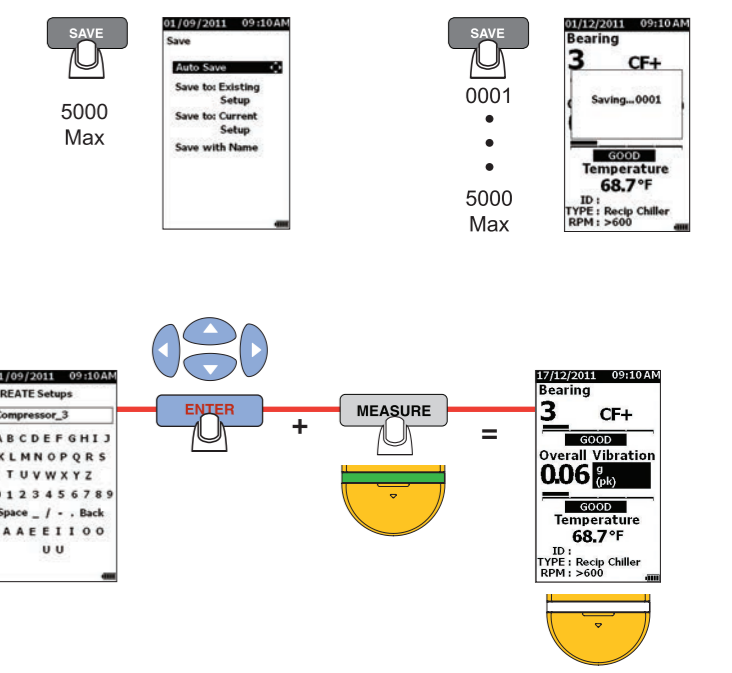

## Save to Existing Setup

