

Power Management ICs for Automotive Body Control

Voltage Detector ICs with Watchdog Timer

**BD37A19FVM, BD37A41FVM, BD87A28FVM, BD87A29FVM
BD87A34FVM, BD87A41FVM, BD99A41F**

No.10039EAT12

●Description

The BD37A19FVM, BD37A41FVM, BD87A28FVM, BD87A29FVM, BD87A34FVM, BD87A41FVM and BD99A41F are watchdog timer reset ICs. It delivers a high precision detection voltage of $\pm 1.5\%$ and a super-low current consumption of 5 μA (Typ.). It can be used in a wide range of electronic devices to monitor power supply voltages and in system operation to prevent runaway operation.

●Features

- 1) High precision detection voltage: $\pm 1.5\%$, $\pm 2.5\%$ ($T_a = -40^\circ\text{C}$ to 105°C)
- 2) Super-low current consumption: 5 μA (Typ.)
- 3) Built-in watchdog timer
- 4) Reset delay time can be set with the CT pin's external capacitance.
- 5) Watchdog timer monitor time and reset time can be set with the CTW pin's external capacitance.
- 6) Output circuit type: N-channel open drain
- 7) Package: MSOP8 (BD37A□□FVM, BD87A□□FVM) / SOP8 (BD99A41F)

●Applications

All devices using microcontrollers or DSP, including vehicle equipment, displays, servers, DVD players, and telephone systems.

●Product line

INH logic	H: Active		L: Active
Model	BD37A□□FVM	BD99A41F	BD87A□□FVM
Detection voltage	1.9 V/4.1V	4.1 V	2.8V/2.9V/3.4 V/4.1V

● Absolute maximum ratings (Ta = 25°C)

Parameter	Symbol	Ratings	Unit
Power supply voltage	VDD	-0.3 to 10	V
CT pin voltage	VCT	-0.3 to VDD + 0.3	V
CTW pin voltage	VCTW	-0.3 to VDD + 0.3	V
RESET pin voltage	VRESET	-0.3 to VDD + 0.3	V
INH pin voltage	VINH	-0.3 to VDD + 0.3	V
CLK pin voltage	VCLK	-0.3 to VDD + 0.3	V
Power dissipation	Pd	470 ^{*1}	mW
		550 ^{*2}	
Operating ambient temperature	Topr	-40 to + 105	°C
Storage temperature	Tstg	-55 to + 125	°C
Maximum junction temperature	Tjmax	125	°C

*1 MSOP8 : Reduced by 4.70 mW/°C over 25°C, when mounted on a glass epoxy board (70 mm × 70 mm × 1.6 mm).

*2 SOP8 : Reduced by 5.50 mW/°C over 25°C, when mounted on a glass epoxy board (70 mm × 70 mm × 1.6 mm).

● Recommended operating ranges (Ta = -40°C to 105°C)

Parameter	Symbol	Min.	Max.	Unit
RESET power supply voltage	VDD RESET	1.0	10	V
WDT power supply voltage	VDD WDT	2.5	10	V

●Electrical characteristics (Unless otherwise specified, Ta = -40°C to 105°C, VDD = 5 V)

Parameter	Symbol	Limits			Unit	Conditions	
		Min.	Typ.	Max.			
[Overall]							
Total supply current 1 (during WDT operation)	IDD1	—	5	14	μA	INH : WDT ON Logic Input CTW = 0.1 μF	
Total supply current 2 (when WDT stopped)	IDD2	—	5	14	μA	INH : WDT OFF Logic Input	
Output leak current	Ileak	—	—	1	μA	VDD = VDS = 10 V	
Output current capacity	IOL	0.7	—	—	mA	VDD = 1.2 V, VDS = 0.5 V	
[RESET]							
Detection voltage 1	1.9V Detect	VDET1	1.871	1.900	1.929	V	Ta = 25°C
	2.8V Detect	VDET1	2.758	2.800	2.842	V	Ta = 25°C
	2.9V Detect	VDET1	2.886	2.930	2.974	V	Ta = 25°C
	3.4V Detect	VDET1	3.349	3.400	3.451	V	Ta = 25°C
	4.1V Detect	VDET1	4.039	4.100	4.162	V	Ta = 25°C
Detection voltage 2	1.9V Detect	VDET2	1.852	1.900	1.948	V	Ta = -40 to 105°C
	2.8V Detect	VDET2	2.730	2.800	2.870	V	Ta = -40 to 105°C
	2.9V Detect	VDET2	2.857	2.930	3.003	V	Ta = -40 to 105°C
	3.4V Detect	VDET2	3.315	3.400	3.485	V	Ta = -40 to 105°C
	4.1V Detect	VDET2	4.007	4.100	4.202	V	Ta = -40 to 105°C
Hysteresis width	1.9V Detect	Vrhys	VDET × 0.03	VDET × 0.13	VDET × 0.19	V	Ta = -40 to 105°C
	2.8V Detect	Vrhys	VDET × 0.018	VDET × 0.045	VDET × 0.060	V	Ta = -40 to 105°C
	2.9V Detect	Vrhys	VDET × 0.02	VDET × 0.05	VDET × 0.06	V	Ta = -40 to 105°C
	3.4V Detect	Vrhys	VDET × 0.02	VDET × 0.05	VDET × 0.07	V	Ta = -40 to 105°C
	4.1V Detect	Vrhys	VDET × 0.018	VDET × 0.035	VDET × 0.050	V	Ta = -40 to 105°C
RESET transmission delay time: low → high	TPLH	3.9	6.9	10.1	ms	CT = 0.001 μF ⁻¹ When VDD = VDET ±0.5 V	
Delay circuit resistance	Rrst	5.8	10.0	14.5	MΩ	VCT = GND	
Delay pin threshold voltage	VCTH	VDD × 0.3	VDD × 0.45	VDD × 0.6	V	RL = 470 KΩ	
Delay pin output current	ICT	150	—	—	μA	VDD = 1.50 V, VCT = 0.5 V	
Min. operating voltage	VOPL	1.0	—	—	V	VOL ≤ 0.4 V, RL = 470 KΩ	
[WDT]							
WDT monitor time	TwH	7.0	10.0	20.0	ms	CTW = 0.01 μF ⁻²	
WDT reset time	TwL	2.4	3.3	7.0	ms	CTW = 0.01 μF ⁻³	
Clock input pulse width	TWCLK	500	—	—	ns		
CLK high threshold voltage	VCLKH	VDD × 0.8	—	VDD	V		
CLK low threshold voltage	VCLKL	0	—	VDD × 0.3	V		
CLK high threshold voltage	VINHH	VDD × 0.8	—	VDD	V		
CLK low threshold voltage	VINHL	0	—	VDD × 0.3	V		
CTW charge current	ICTWC	0.25	0.50	0.75	μA	VCTW = 0.2 V	
CTW discharge current	ICTWO	0.75	1.50	2.00	μA	VCTW = 0.8 V	

*1 TPLH can be varied by changing the CT capacitance value.
 $TPLH (s) \approx 0.69 \times Rrst (M\Omega) \times CT (\mu F)$ Rrst = 10 MΩ (Typ.)

*2 TwH can be varied by changing the CT capacitance value.
 $TwH (s) \approx (0.5 \times CTW (\mu F)) / ICTWC (\mu A)$ ICTWC = 0.5 μA (Typ.)

*3 TwL can be varied by changing the CTW capacitance value.
 $TwL (s) \approx (0.5 \times CTW (\mu F)) / ICTWO (\mu A)$ ICTWO = 1.5 μA (Typ.)

○ Note: This IC is not designed to be radiation-resistant.

●Reference data (Unless otherwise specified, Ta = 25°C) : 4.1V Detection

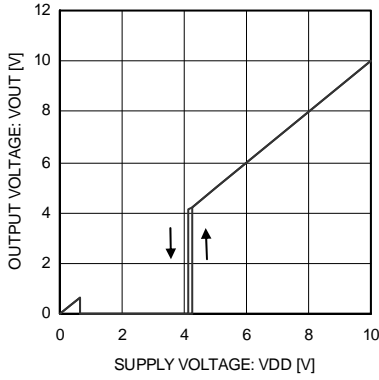

Fig.1 Detection Voltage

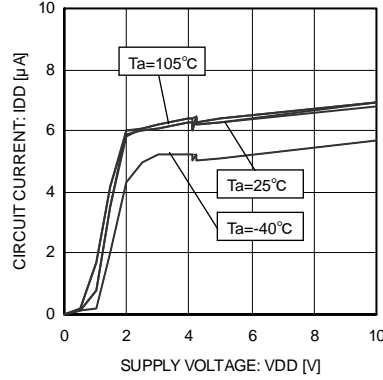

Fig.2 Total Supply Current

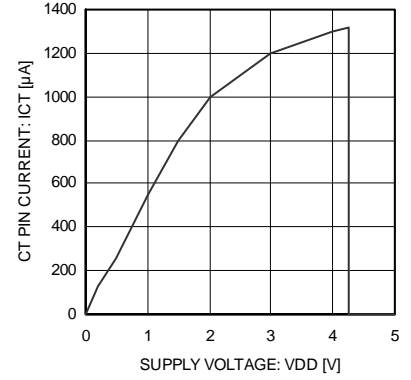

Fig.3 Delay Pin Current vs Power Supply Voltage

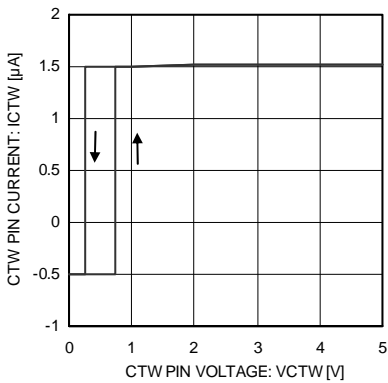

Fig.4 CTW Charge Discharge Current

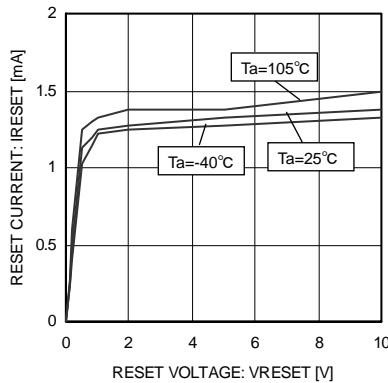

Fig.5 Output Current

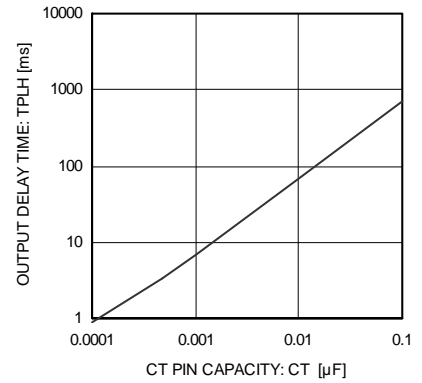

Fig.6 RESET Transmission Delay Time vs Capacitance

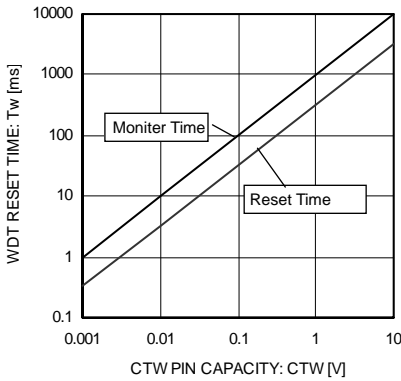

Fig.7 WDT Time vs Capacitance

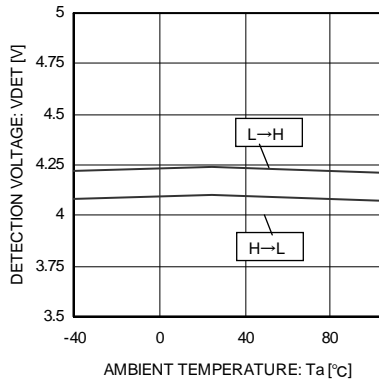

Fig.8 Detection Voltage vs Temperature

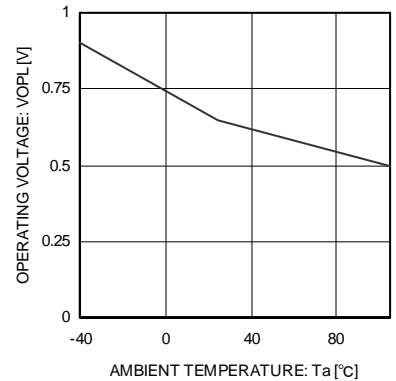

Fig.9 Operating Marginal Voltage vs Temperature

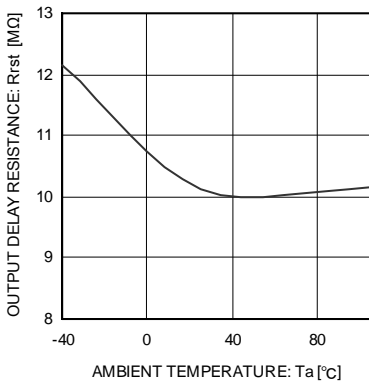

Fig.10 CT Pin Circuit Resistance vs Temperature

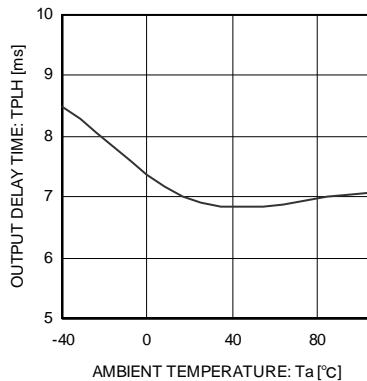

Fig.11 RESET Transmission Delay Time vs Temperature

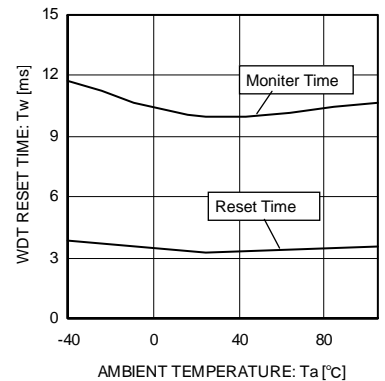
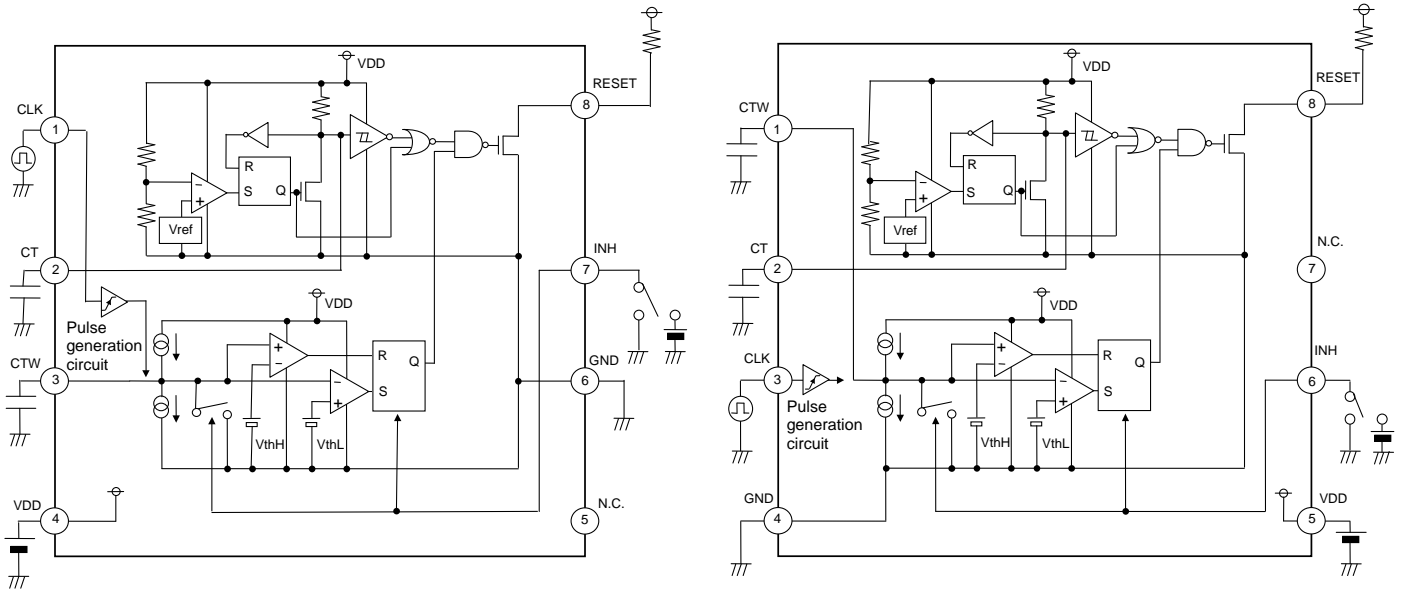

Fig.12 WDT Time vs Temperature

●Block diagram

BD37A□□FVM

BD87A□□FVM / BD99A41F



CT pin capacitor: 470 pF to 3.3 μF
CTW pin capacitor: 0.001 μF to 10 μF

Fig.13

●Pin assignments

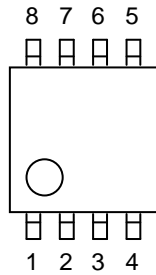

Fig.14

BD37A□□FVM

BD87A□□FVM / BD99A41F

No.	Pin name	Function
1	CLK	Clock input from microcontroller
2	CT	Reset delay time setting capacitor connection pin
3	CTW	WDT time setting capacitor connection pin
4	VDD	Power supply pin
5	N.C.	NC pin
6	GND	GND pin
7	INH	WDT on/off setting pin INH=H/L:WDT=ON/OFF
8	RESET	Reset output pin

No.	Pin name	Function
1	CTW	WDT time setting capacitor connection pin
2	CT	Reset delay time setting capacitor connection pin
3	CLK	Clock input from microcontroller
4	GND	GND pin
5	VDD	Power supply pin
6	INH	WDT on/off setting pin INH=H/L:WDT=OFF/ON(BD87A□□FVM) INH=H/L:WDT=ON/OFF(BD99A41F)
7	N.C.	NC pin
8	RESET	Reset output pin

● I/O Circuit diagram

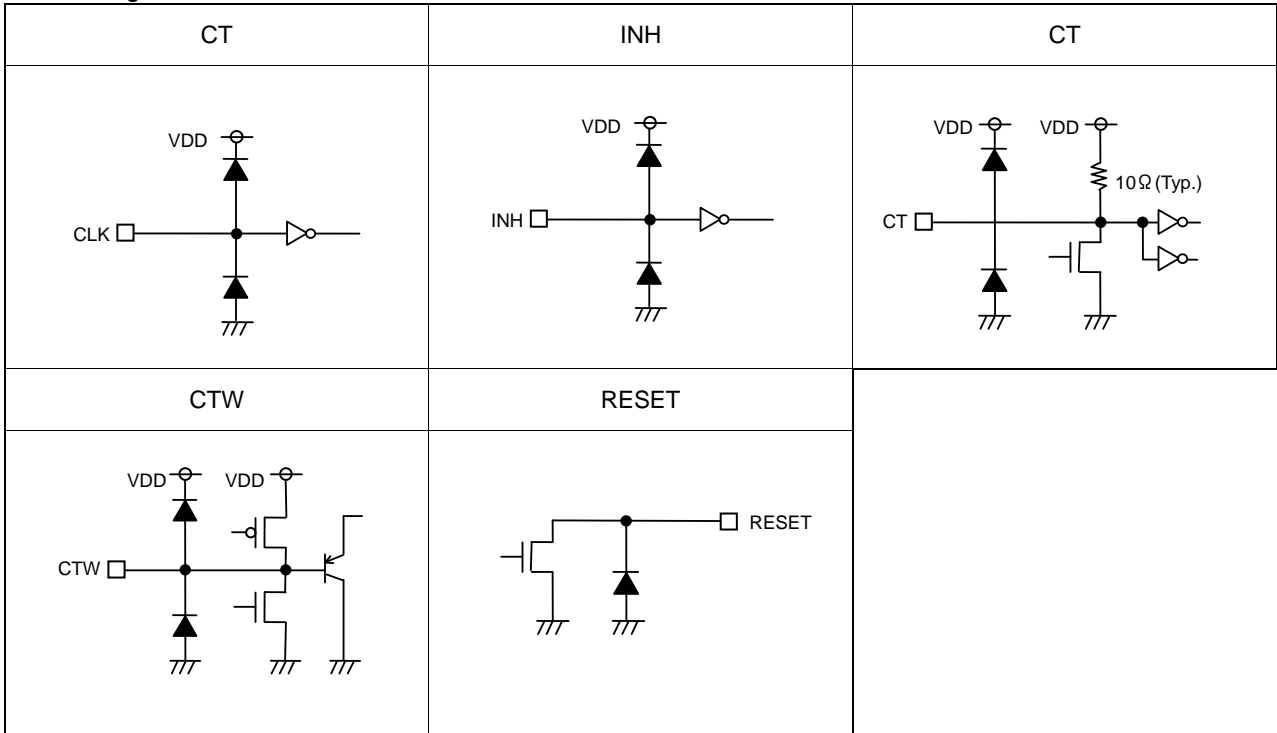

Fig.15

● Timing chart

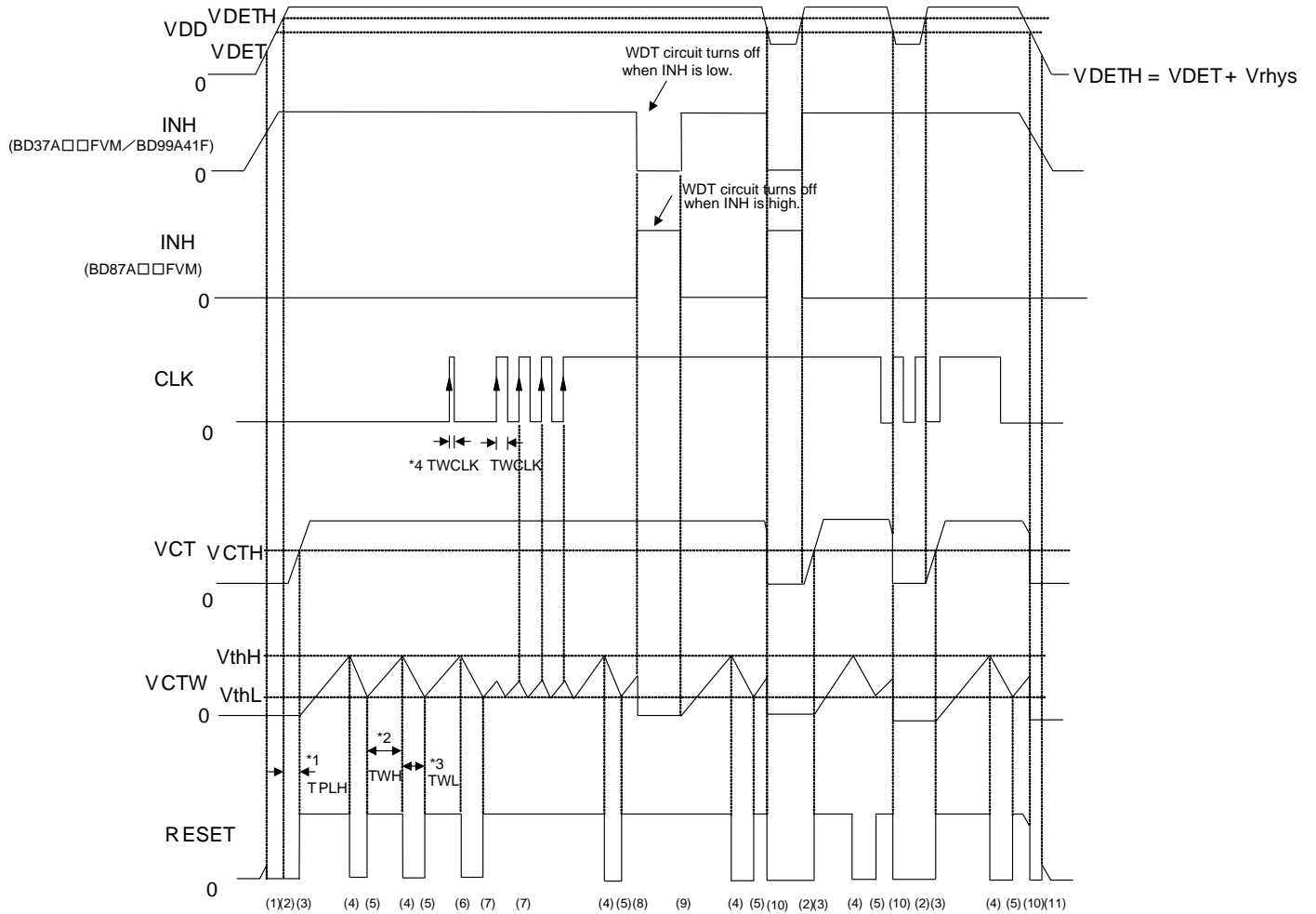

Fig.16

●Explanation

- 1) The RESET pin voltage (RESET) switches to low when the power supply voltage (VDD) falls to 0.8 V.
- 2) The external capacitor connected to the CT pin begins to charge when VDD rises above the reset detection voltage (VDETH). The RESET signal stays low until VDD reaches the VDETH voltage and switches to high when VDD reaches or exceeds the VDETH voltage. The RESET transmission delay time TPLH allowed to elapse before RESET switches from low to high is given by the following equation:

$$T_{PLH} (s) \approx 0.69 \times R_{rst} \times C_T (\mu F) \cdot \cdot [1]$$
 Rrst denotes the IC's built-in resistance and is designed to be 10 MΩ (Typ.). CT denotes the external capacitor connected to the CT pin.
- 3) The external capacitor connected to the CTW pin begins to charge when RESET rises, triggering the watchdog timer.
- 4) The CTW pin state switches from charge to discharge when the CTW pin voltage (VCTW) reaches VthH, and RESET switches from high to low. The watchdog timer monitor time TWH is given by the following equation:

$$T_{WH} (s) \approx (0.5 \times C_{TW} (\mu F)) / (I_{CTWC}) \cdot \cdot [2]$$
 ICTWC denotes the CTW charge current and is designed to be 0.50 μA (Typ.). CTW denotes the external capacitor connected to the CTW pin.
- 5) The CTW pin state switches from charge to discharge when VCTW reaches VthL, and RESET switches from low to high. The watchdog timer reset time TWL is given by the following equation:

$$T_{WL} (s) \approx (0.5 \times C_{TW} (\mu F)) / (I_{CTWO}) \cdot \cdot [3]$$
 ICTWO denotes the CTW discharge current and is designed to be 1.50 μA (Typ.).
- 6) The CTW pin state may not switch from charge to discharge when the CLK input pulse width TWCLK is short. Use a TWCLK input pulse width of at least 500 ns.

$$T_{WCLK} \geq 500 \text{ ns (Min.)}$$
- 7) When a pulse (positive edge trigger) of at least 500 ns is input to the CLK pin while the CTW pin is charging, the CTW state switches from charge to discharge. Once it discharges to VthL, it will charge again.
- 8) Watchdog timer operation is forced off when the INH pin switches to low:BD37A□□FVM (Switches to high: BD87A□□FVM, BD97A41F). At that time, only the watchdog timer is turned off. Reset detection is performed normally.
- 9) The watchdog timer function turns on when the INH pin switches to high. The external capacitor connected to the CTW pin begins to charge at that time.
- 10) RESET switches from high to low when VDD falls to the RESET detection voltage (VDET) or lower.
- 11) When VDD falls to 0 V, the RESET signal stays low until VDD reaches 0.8 V.

●Heat reduction curve

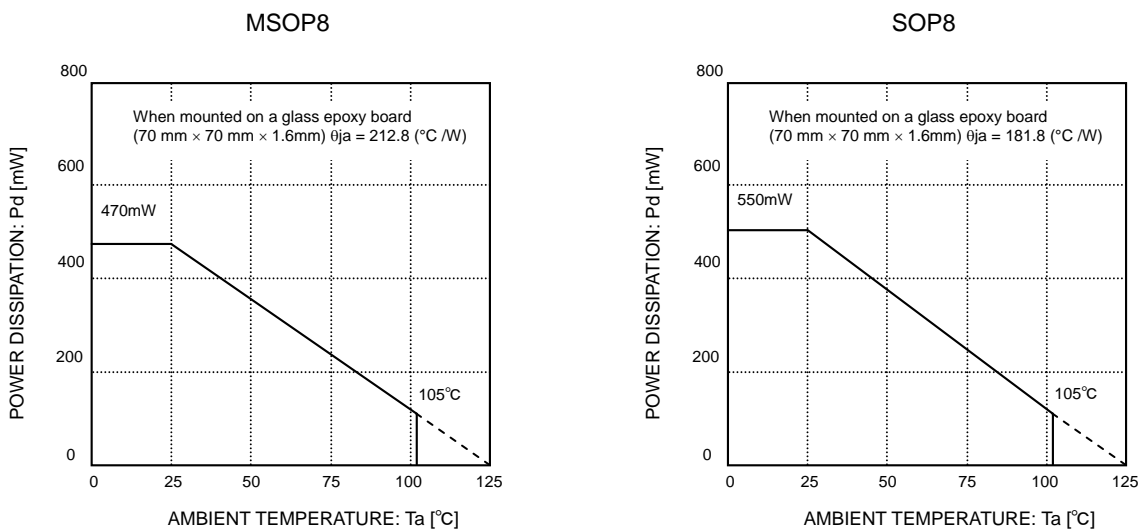

Fig.17

●External settings for pins and precautions

- 1) Connect a capacitor (0.001 μF to 1,000 μF) between the VDD and GND pins when the power line impedance is high. Use of the IC when the power line impedance is high may result in oscillation.
- 2) External capacitance
A capacitor must be connected to the CTW pin. When using a large capacitor such as 1 μF, the INH pin must allow a CTW discharge time of at least 2 ms. The power-on reset time is given by equation [1] on page 5. The WDT time is given by equations [2] and [3] on page 5, 6. The setting times are proportional to the capacitance value from the equations, so the maximum and minimum setting times can be calculated from the electrical characteristics according to the capacitance. Note however that the electrical characteristics do not include the external capacitor's temperature characteristics.

●Notes for use

- 1) Absolute maximum ratings
An excess in the absolute maximum ratings, such as supply voltage, temperature range of operating conditions, etc., can break down the devices, thus making impossible to identify breaking mode, such as a short circuit or an open circuit. If any over rated values will expect to exceed the absolute maximum ratings, consider adding circuit protection devices, such as fuses.
- 2) GND voltage
The potential of GND pin must be minimum potential in all operating conditions.
- 3) Thermal design
Use a thermal design that allows for a sufficient margin in light of the power dissipation (Pd) in actual operating conditions.
- 4) Inter-pin shorts and mounting errors
Use caution when positioning the IC for mounting on printed circuit boards. The IC may be damaged if there is any connection error or if pins are shorted together.
- 5) Actions in strong electromagnetic field
Use caution when using the IC in the presence of a strong electromagnetic field as doing so may cause the IC to malfunction.
- 6) Testing on application boards
When testing the IC on an application board, connecting a capacitor to a pin with low impedance subjects the IC to stress. Always discharge capacitors after each process or step. Always turn the IC's power supply off before connecting it to or removing it from a jig or fixture during the inspection process. Ground the IC during assembly steps as an antistatic measure. Use similar precaution when transporting or storing the IC.
- 7) Regarding input pin of the IC
This monolithic IC contains P+ isolation and P substrate layers between adjacent elements in order to keep them isolated. P-N junctions are formed at the intersection of these P layers with the N layers of other elements, creating a parasitic diode or transistor. For example, the relation between each potential is as follows:
○When GND > Pin A and GND > Pin B, the P-N junction operates as a parasitic diode.
○When GND > Pin B, the P-N junction operates as a parasitic transistor.
Parasitic diodes can occur inevitable in the structure of the IC. The operation of parasitic diodes can result in mutual interference among circuits, operational faults, or physical damage. Accordingly, methods by which parasitic diodes operate, such as applying a voltage that is lower than the GND (P substrate) voltage to an input pin, should not be used.

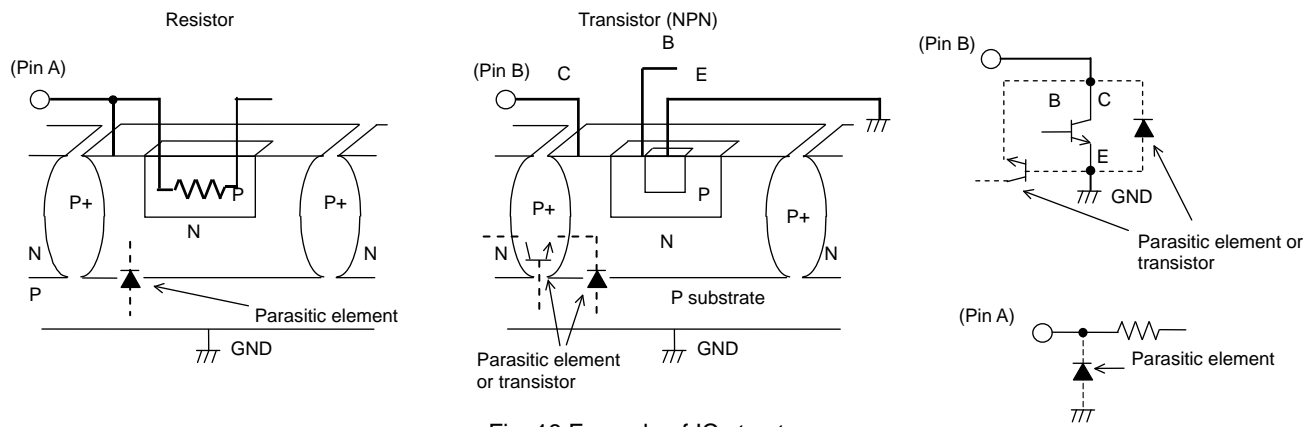

Fig. 18 Example of IC structure

8) Ground Wiring Pattern

When using both small signal and large current GND patterns, it is recommended to isolate the two ground patterns, placing a single ground point at the ground potential of application so that the pattern wiring resistance and voltage variations caused by large currents do not cause variations in the small signal ground voltage. Be careful not to change the GND wiring pattern of any external components, either.

- 9) Applications or inspection processes with modes where the potentials of the VDD pin and other pins may be reversed from their normal states may cause damage to the IC's internal circuitry or elements. Use an output pin capacitance of 1000 μ F or lower in case VDD is shorted with the GND pin while the external capacitor is charged. It is recommended to insert a diode for preventing back current flow in series with VDD or bypass diodes between Vcc and each pin.

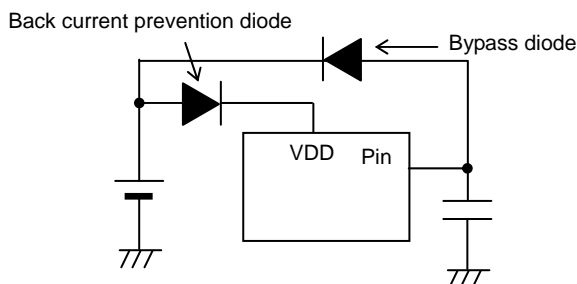

Fig.19

- 10) When VDD falls below the operating marginal voltage, output will be open. When output is being pulled up to input, output will be equivalent to VDD.
- 11) Input pin
The CLK and INH pins comprise inverter gates and should not be left open. (These pins should be either pulled up or down.) Input to the CLK pin is detected using a positive edge trigger and does not affect the CLK signal duty. Input the trigger to the CLK pin within the TWH time.

●Ordering part number

B	D	3	7	A	1	9	F	V	M	-	T	R
Part No. BD		Part No. 37A19, 37A41, 87A28, 87A29, 87A34, 87A41 99A41					Package FVM : MSOP8 F : SOP8			Packaging and forming specification TR: Embossed tape and reel (MSOP8) E2: Embossed tape and reel (SOP8)		

MSOP8

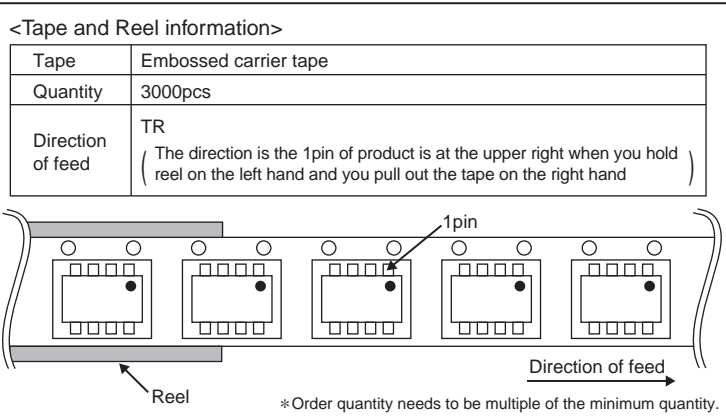
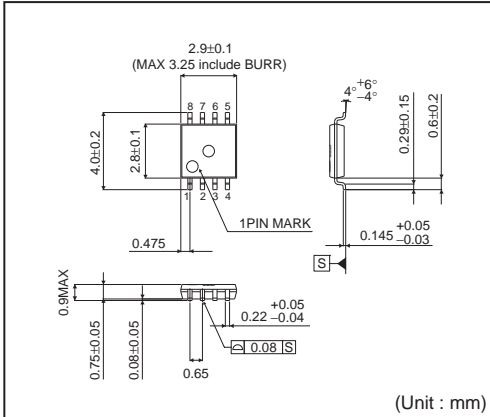

SOP8

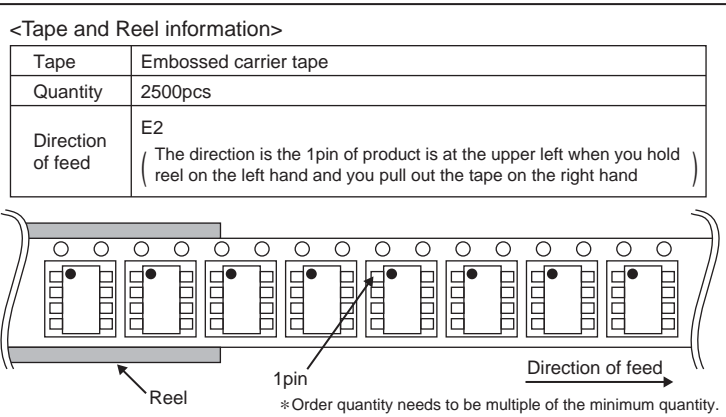
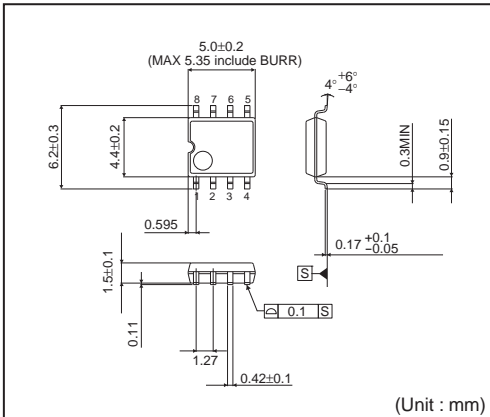

Notes

No copying or reproduction of this document, in part or in whole, is permitted without the consent of ROHM Co.,Ltd.

The content specified herein is subject to change for improvement without notice.

The content specified herein is for the purpose of introducing ROHM's products (hereinafter "Products"). If you wish to use any such Product, please be sure to refer to the specifications, which can be obtained from ROHM upon request.

Examples of application circuits, circuit constants and any other information contained herein illustrate the standard usage and operations of the Products. The peripheral conditions must be taken into account when designing circuits for mass production.

Great care was taken in ensuring the accuracy of the information specified in this document. However, should you incur any damage arising from any inaccuracy or misprint of such information, ROHM shall bear no responsibility for such damage.

The technical information specified herein is intended only to show the typical functions of and examples of application circuits for the Products. ROHM does not grant you, explicitly or implicitly, any license to use or exercise intellectual property or other rights held by ROHM and other parties. ROHM shall bear no responsibility whatsoever for any dispute arising from the use of such technical information.

The Products specified in this document are intended to be used with general-use electronic equipment or devices (such as audio visual equipment, office-automation equipment, communication devices, electronic appliances and amusement devices).

The Products specified in this document are not designed to be radiation tolerant.

While ROHM always makes efforts to enhance the quality and reliability of its Products, a Product may fail or malfunction for a variety of reasons.

Please be sure to implement in your equipment using the Products safety measures to guard against the possibility of physical injury, fire or any other damage caused in the event of the failure of any Product, such as derating, redundancy, fire control and fail-safe designs. ROHM shall bear no responsibility whatsoever for your use of any Product outside of the prescribed scope or not in accordance with the instruction manual.

The Products are not designed or manufactured to be used with any equipment, device or system which requires an extremely high level of reliability the failure or malfunction of which may result in a direct threat to human life or create a risk of human injury (such as a medical instrument, transportation equipment, aerospace machinery, nuclear-reactor controller, fuel-controller or other safety device). ROHM shall bear no responsibility in any way for use of any of the Products for the above special purposes. If a Product is intended to be used for any such special purpose, please contact a ROHM sales representative before purchasing.

If you intend to export or ship overseas any Product or technology specified herein that may be controlled under the Foreign Exchange and the Foreign Trade Law, you will be required to obtain a license or permit under the Law.



Thank you for your accessing to ROHM product informations.
More detail product informations and catalogs are available, please contact us.

ROHM Customer Support System

<http://www.rohm.com/contact/>