

60x60x25 mm

13.9~23.5 CFM



■ Specifications

Model	Bearing	Rating Voltage	Power Current	Power Consumption	Speed	Air Flow	Static Pressure	Noise	Weight	Curve
	2BALL Sleeve	(VDC)	(mA)	(WATTS)	(RPM)	(CFM)	(Inch-H ₂ O)	(dB(A))	(g)	
EE60251B1-000U-999	☉	12	120	1.44	4500	23.5	0.21	34.5	50.0	1
EE60251B2-000U-999	☉	12	78	0.94	3800	19.3	0.15	30.0	50.0	2
EE60251B3-000U-999	☉	12	58	0.70	3000	13.9	0.08	20.0	50.0	3
EE60252B1-000U-A99	☉	24	70	1.68	4500	23.5	0.21	34.5	50.0	1
EE60252B2-000U-A99	☉	24	47	1.13	3800	19.3	0.15	30.0	50.0	2
EE60252B3-000U-A99	☉	24	30	0.72	3000	13.9	0.08	20.0	50.0	3

■ Air Flow-Static Pressure Characteristics

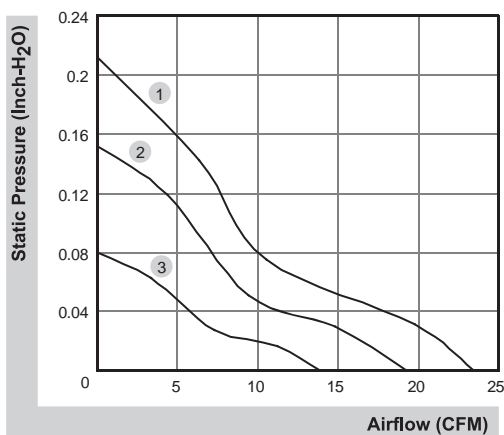

■ External dimensions(mm)

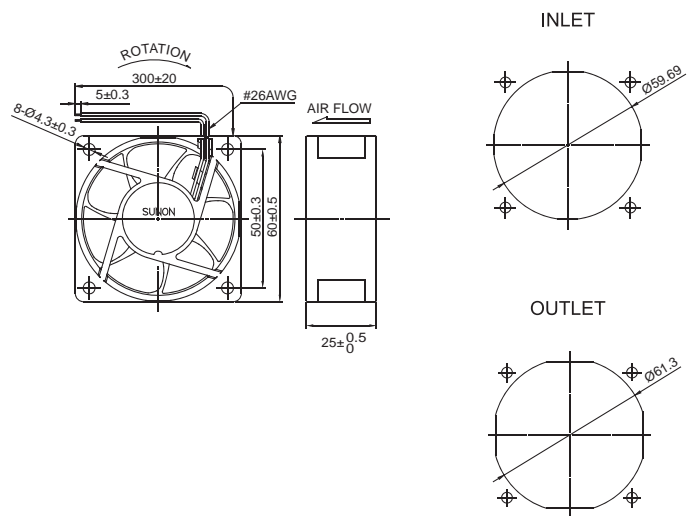

*All model could be customized. Please contact with Sunon Sales.

*Specifications are subject to change without notice. Please Visit SUNON website at <http://www.sunon.com> for update information.