

ISL95338EVAL1Z

User's Manual: Evaluation Board

Battery and Optical

ISL95338EVAL1Z

Evaluation Board

UG128
Rev.0.00
Aug 17, 2017

1. Overview

The [ISL95338](#) is a bidirectional buck-boost voltage regulator, which provides bidirectional buck-boost voltage regulation and protection features. Intersil's advanced R3™ Technology is used to provide high light-load efficiency, fast transient response, and seamless DCM/CCM transitions.

The ISL95338 takes input power from a wide range of DC power sources (conventional AC/DC ADPs, USB PD ports, travel ADPs, etc.) and safely converts it to a regulated voltage up to 24V. The ISL95338 also can convert a wide range DC power source connected at its output (system side) to a regulated voltage to its input (ADP side). This bidirectional buck-boost regulation feature makes its application very flexible.

The ISL95338 includes various system operation functionalities such as Forward mode enable, Reverse mode enable, programmable soft-start time, and adjustable V_{OUT} in both forward direction and reverse direction. The protection functionalities include OCP, OVP, UVP, OTP, etc.

The ISL95338 has serial communication using SMBus/I²C that allows programming of many critical parameters to deliver a customized solution. These programming parameters include, but are not limited to: output current limit, input current limit, and output voltage setting.

1.1 Key Features

- Bidirectional buck, boost, and buck-boost operation
- Input voltage range 3.8V to 24V (no dead zone)
- Output voltage up to 20V
- Up to 1MHz switching frequency
- Programmable soft-start time
- LDO output for VDD and VDDP
- System status alert function
- Bidirectional internal discharge function
- Active switching for negative voltage transitions
- Bypass mode in both directions
- Forward mode enable, Reverse mode enable
- OCP, OVP, UVP, and OTP protection
- SMBus and auto-increment I²C compatible

1.2 Specifications

- V_{IN} = 3.8V to 24V (no dead zone)
- V_{OUT} = 2.4V to 20V
- f_{SW} = 1MHz maximum

1.3 Ordering Information

| Part Number | Description |
|----------------|--|
| ISL95338EVAL1Z | ISL95338 buck-boost voltage regulator evaluation board |

1.4 Related Literature

- For a full list of related documents, visit our website
 - [ISL95338](#) product page

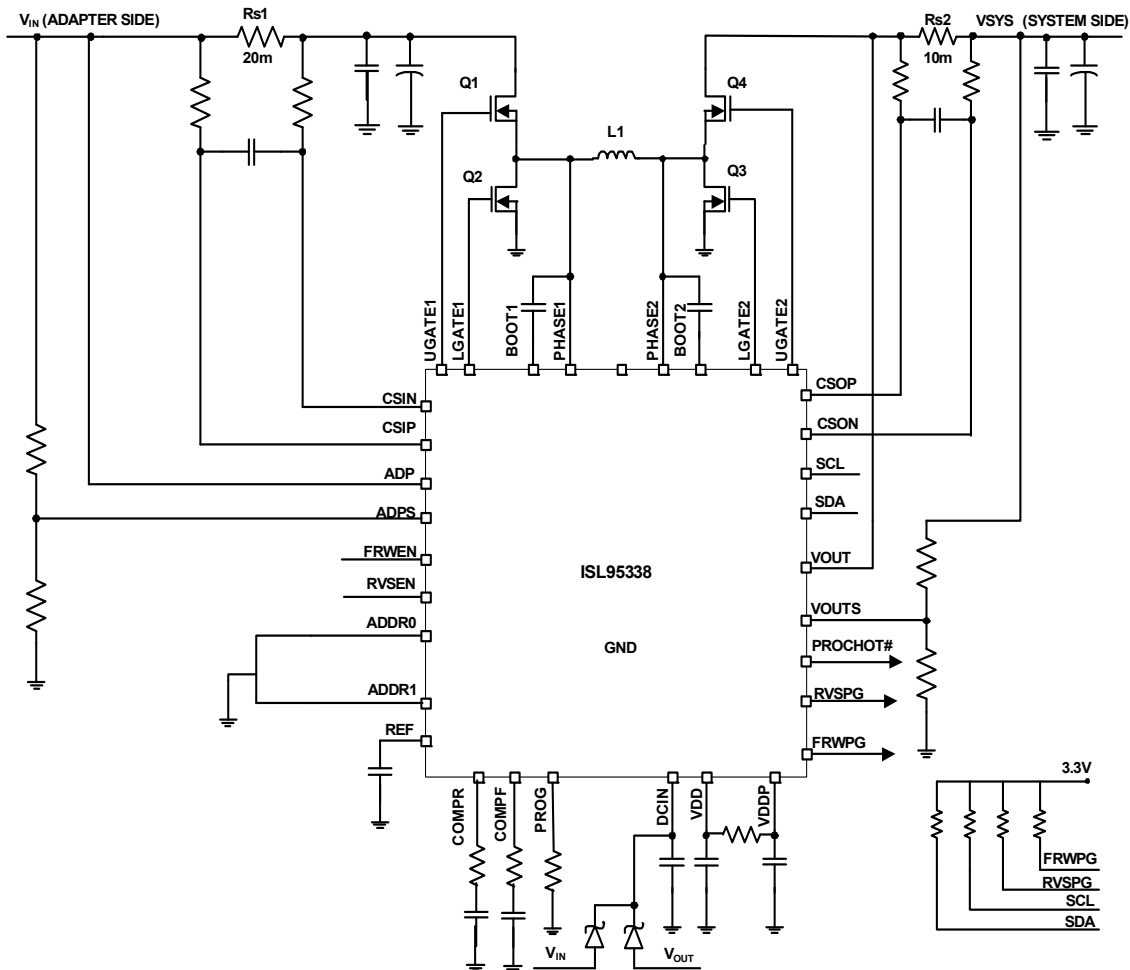

Figure 1. Block Diagram

1.5 Recommended Equipment

- 0V to 25V power supply with at least 6A source current capability
- Electronic load capable of sinking current up to 6A
- Digital Multimeters (DMMs)
- 100MHz quad-trace oscilloscope

2. Functional Description

The ISL95338EVAL1Z provides all circuits required to evaluate the features of the ISL95338. A majority of the features, such as adjustable output voltage in Forward mode and Reverse mode, programmable REF, fast VDAC changing at no load condition, at Buck, Boost and Buck-Boost modes, are available on this evaluation board.

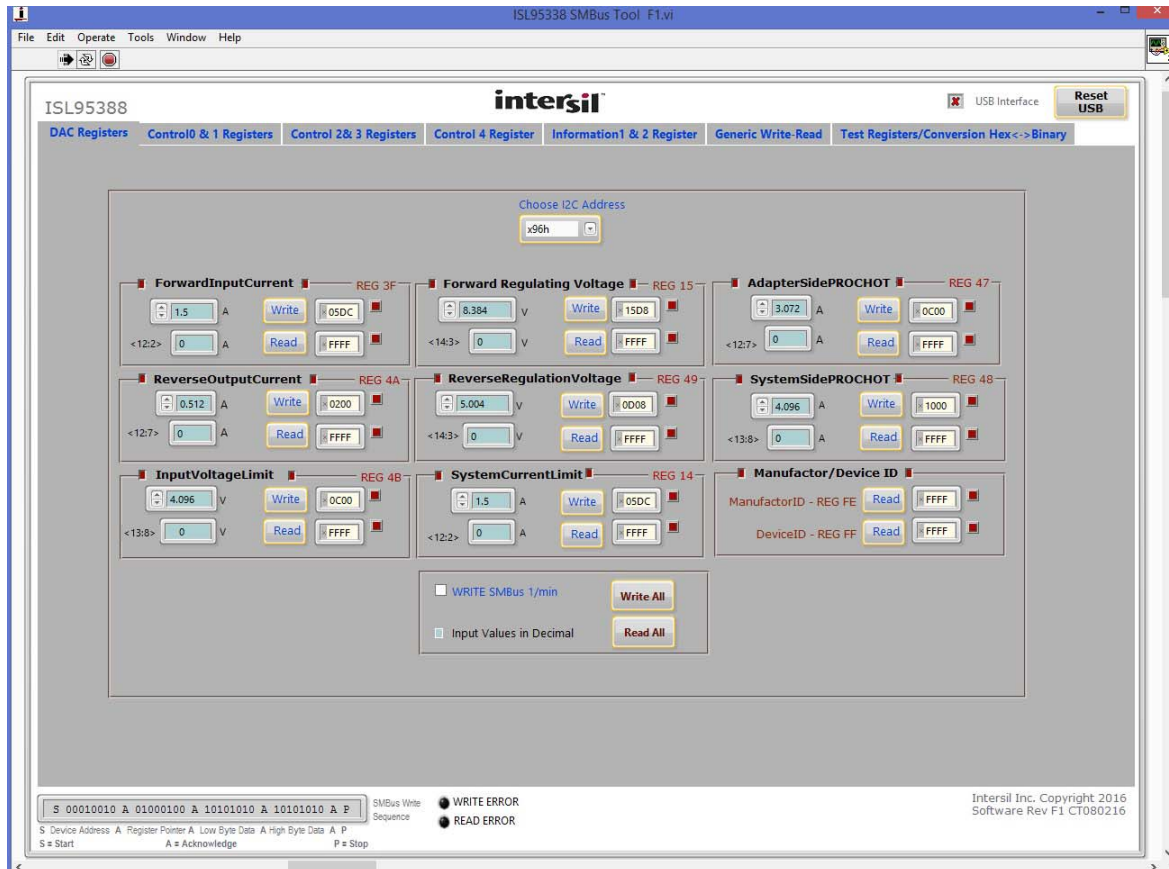

Figure 2. GUI Snapshot

2.1 Quick Start Guide

The ISL95338 can provide bidirectional output voltage up to 20V. The forward output voltage default values can be configured with a standard 1% 0603 resistor (R_{23}) from the PROG pin to GND. Table 21 in the [ISL95338](#) datasheet shows the programming options. After the default forward output voltage is set, this value can also be changed through the SMBus control register, ForwardRegulatingVoltage (0X15H). The reverse output voltage value can be set through the SMBus control register, ReverseRegulatingVoltage (0X49H). The protection values, including forward input current limit, reverse output current limit, input voltage limit, and system side current limit can be programmed through the SMBus control registers, 0X3FH, 0X4AH, 0X4BH, and 0X14H, respectively.

The ISL95338 also provides a programmable SMBus address to support multiple SMBus chips sharing common SMBus, through ADDR0 and ADDR1 pins. Details for programmable addresses are shown in Table 1 of the [ISL95338](#) datasheet.

Three LEDs indicate Forward Power-Good (FWRPG), Reverse Power-Good (RVSPG), and PROCHOT status for the ADP side and system side, respectively. Refer to [Figure 3](#) for the three LED positions. [Figure 3](#), which is the top view of the evaluation board, highlights the key testing points and connection terminals. Use the following steps to evaluate some key functions including Enable Forward mode and Enable Reverse mode. For other features, or more information about ISL95338, refer to [ISL95338](#) datasheet.

2.1.1 Enabling Forward Mode in Buck Mode

- (1) Set the 20V supply to 12V and, with SW1 in the low position, connect the (+) source to the ADP positive terminal and the (-) source to the ADP negative terminal.
- (2) Ensure that jumpers JP4, JP6, and JP7 are shorted. SW1 and SW2 should be in the low position.
- (3) Connect the USB cable to the USB port for SMBus. LED1, 2, and 3 light up.
- (4) Open the ISL95338 GUI. Ensure that SW3 and SW4 are in the low position, and that the ISL95338 address is 0x96H.
- (5) Turn on the power supply. LED2 and 3 go out. Note: A green check mark indicates that the GUI is ready to communicate with the evaluation board. A red X indicates that the GUI is not ready to communicate with the evaluation board. Click the USB reset button until the green check mark shows in the USB interface. If not, check the USB connection, VDD, and SMBus address settings.
- (6) Input 5V to forward regulating voltage register (0x15H), turn SW1 (FRWEN pin) to high to enable the forward output, monitor V_{OUT} and the REF pin waveform. When V_{REF} reaches 5V, LED2 (FWRPG) lights up.
- (7) Measure V_{OUT} using the DMM across the system positive “+” and system negative “-”. V_{OUT} should read 5V. The current meter on the supply should read <100mA. Monitor PH1 to observe Buck mode operation.

Note: If the load is added on the system side, ensure the current limit values in the system current limit and forward input current limit registers are not hit. The soft-start time can be set by changing the capacitor values connected on the REF pin. Refer to the [ISL95338](#) datasheet.

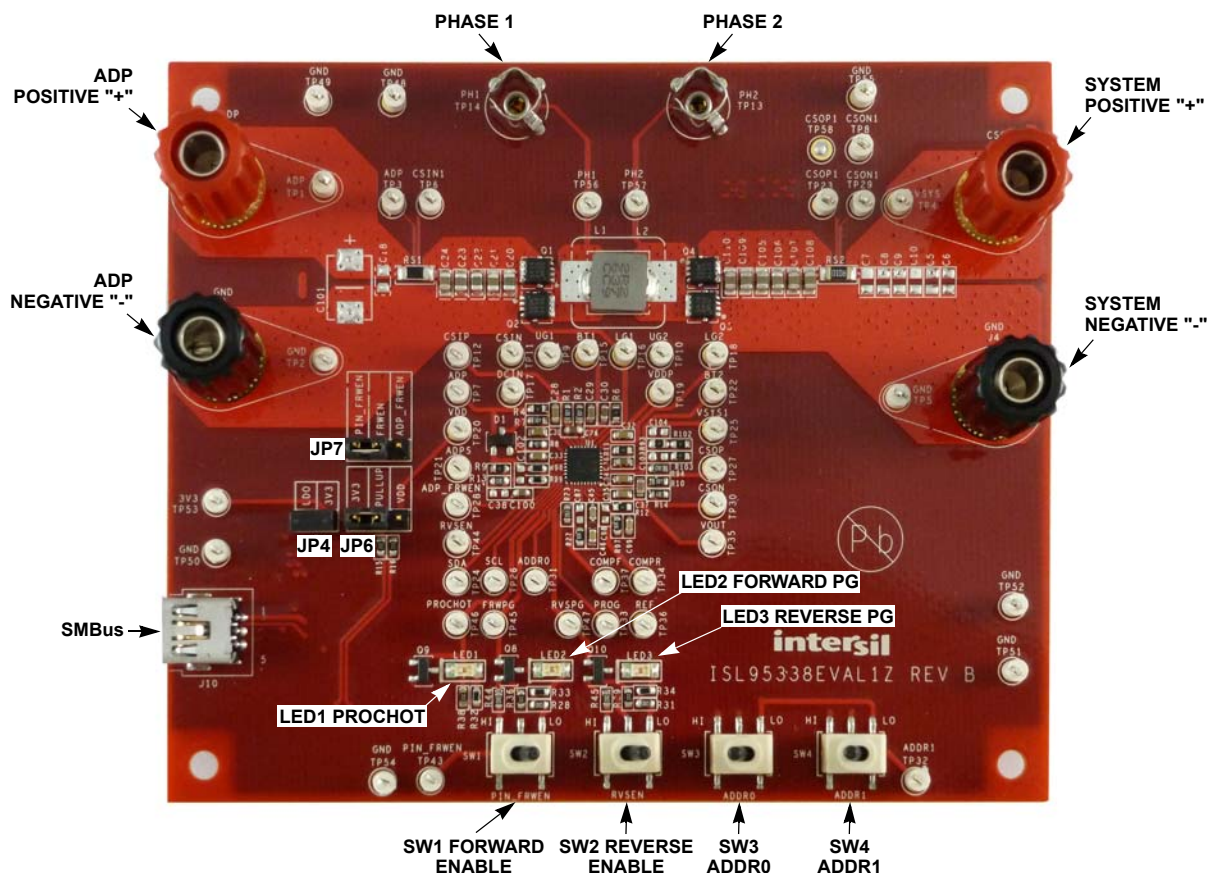

Figure 3. Evaluation Board Connection Guideline

2.1.2 Enabling Reverse Mode in Buck Mode

- (1) Set the 20V supply to 12V and, with SW1 in the low position, connect the (+) source to the system positive terminal and the (-) source to the system negative terminal.
- (2) Ensure that jumpers JP4, JP6, and JP7 are shorted. SW1 and SW2 should be in the low position.
- (3) Connect the USB cable to the USB port for SMBus. LED1, 2, and 3 light up.
- (4) Open ISL95338 GUI. Ensure that SW3 and SW4 are in the low position, and that the ISL95338 address is 0x96H.
- (5) Turn on the power supply. Note: A green check mark indicates that the GUI is ready to communicate with the evaluation board. A red X indicates that the GUI is not ready to communicate with the evaluation board. Click the USB reset button until the green check mark shows in the USB interface. If not, check the USB connection, VDD, and SMBus address settings.
- (6) Input 5V to reverse regulating voltage register (0x49H), turn SW2 (RVSEN pin) to high to enable reverse output, monitor V_{OUT} and the REF pin waveform. When V_{REF} reaches 5V, LED3 (RVSPG) lights up.
- (7) Measure V_{OUT} using the DMM across the ADP positive “+” and ADP negative “-”. V_{OUT} should read 5V. The current meter on the supply should read <100mA. Monitor PH2 to observe Buck mode operation.

Note: If the load is added on the ADP side, ensure the current limit value in the reverse output current register is not hit. The soft-start time can be set by changing capacitor values connecting on REF pin. Refer to [ISL95338](#) datasheet.

3. PCB Layout Guidelines

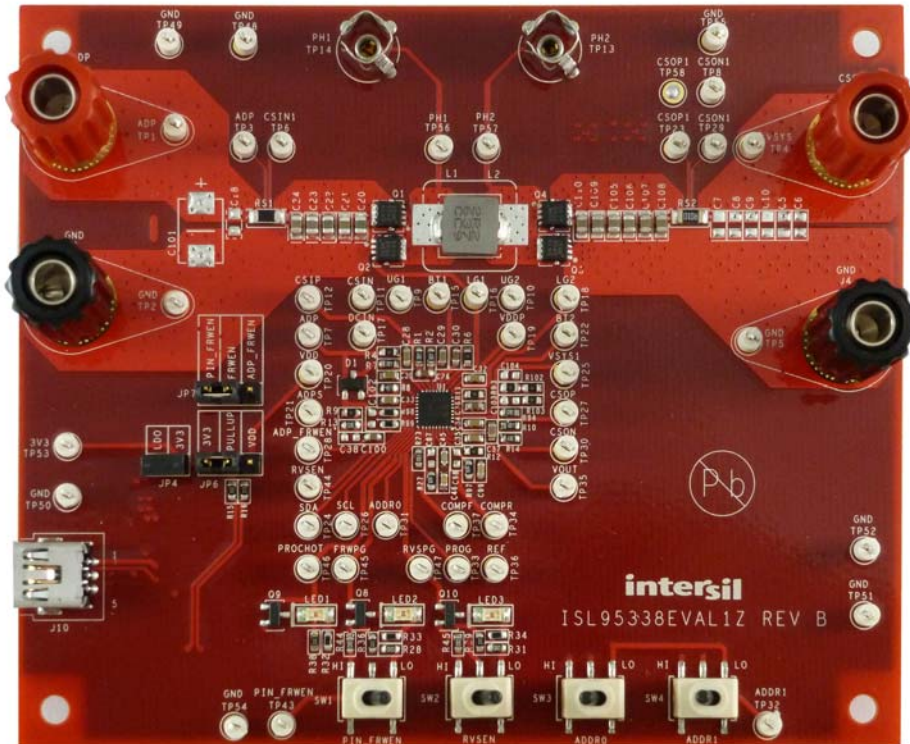

Figure 4. Evaluation Board Top View

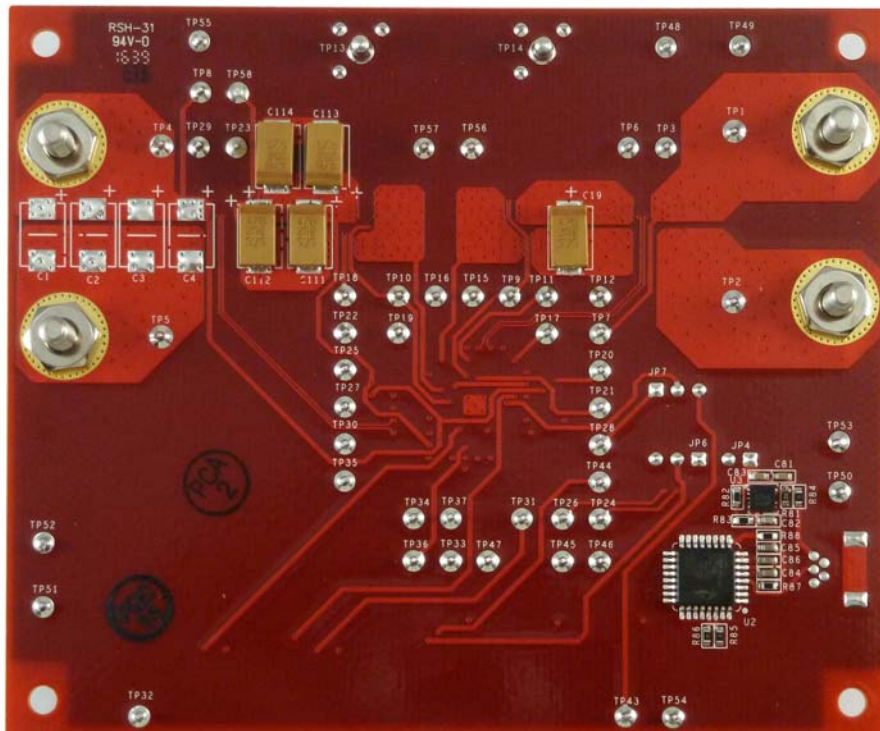
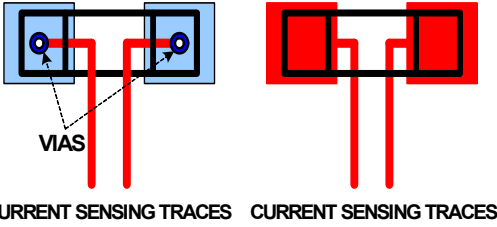
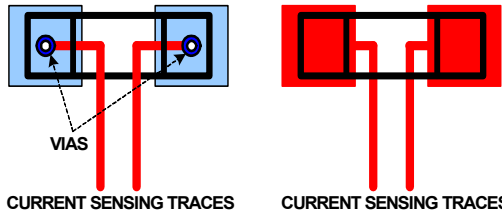

Figure 5. Evaluation Board Bottom View

3.1 Layout Guidelines

| Pin # | Pin Name | Layout Guidelines |
|---------------|----------|--|
| BOTTOM PAD 33 | GND | Connect this ground pad to the ground plane through low impedance path. We recommend using at least five vias to connect to ground planes in the PCB to ensure there is sufficient thermal dissipation directly under the IC. |
| 1 | CSOP | <p>Run two dedicated traces with decent width in parallel (close to each other to minimize the loop area) from the two terminals of the battery current sensing resistor to the IC. Place the differential mode and common-mode RC filter components in general proximity of the controller.</p> <p>Route the current sensing traces through vias to connect the center of the pads; or route the traces into the pads from the inside of the current sensing resistor. The following drawings show the two preferred ways of routing current sensing traces.</p>  |
| 2 | CSOP | |
| 3 | VOUTS | Signal pin. Provides feedback for the system bus voltage. Place the optional RC filter in the general proximity of the controller. Run a dedicated trace from the system bus to the pin and do not route near the switching traces. Do not share the same trace with the signal routing to the DCIN pin OR diodes. |
| 4 | BOOT2 | Switching pin. Place the bootstrap capacitor in the general proximity of the controller. Use a decent wide trace. Avoid any sensitive analog signal trace from crossing over or getting close. |
| 5 | UGATE2 | <p>Run these two traces in parallel fashion with decent width. Avoid any sensitive analog signal trace from crossing over or getting close. Recommend routing PHASE2 trace to high-side MOSFET source pin instead of general copper.</p> <p>The IC should be placed close to the switching MOSFETs gate terminals and keep the gate drive signal traces short for a clean MOSFET drive. The IC can be placed on the opposite side of the switching MOSFETs.</p> <p>Place the output capacitors as close as possible to the switching high-side MOSFET drain and the low-side MOSFET source; and use shortest PCB trace connection. Place these capacitors on the same PCB layer with the MOSFETs instead of on different layers and using vias to make the connection.</p> <p>Place the inductor terminal to the switching high-side MOSFET drain and low-side MOSFET source terminal as close as possible. Minimize this phase node area to lower the electrical and magnetic field radiation but make this phase node area big enough to carry the current. Place the inductor and the switching MOSFETs on the same layer of the PCB.</p> |
| 6 | PHASE2 | |
| 7 | LGATE2 | Switching pin. The run LGATE2 trace in parallel with the UGATE2 and PHASE2 traces on the same PCB layer. Use decent width. Avoid any sensitive analog signal trace from crossing over or getting close. |
| 8 | VDDP | Place the decoupling capacitor in general proximity of the controller. Run the trace connecting to VDD pin with decent width. |
| 9 | LGATE1 | Switching pin. Run the LGATE1 trace in parallel with the UGATE1 and PHASE1 traces on the same PCB layer. Use decent width. Avoid any sensitive analog signal trace from crossing over or getting close. |
| 10 | PHASE1 | <p>Run these two traces in parallel fashion with decent width. Avoid any sensitive analog signal trace from crossing over or getting close. We recommend routing the PHASE1 trace to the high-side MOSFET source pin instead of general copper.</p> <p>The IC should be placed close to the switching MOSFETs gate terminals and keep the gate drive signal traces short for a clean MOSFET drive. The IC can be placed on the opposite side of the switching MOSFETs.</p> <p>Place the input capacitors as close as possible to the switching high-side MOSFET drain and the low-side MOSFET source; and use shortest PCB trace connection. Place these capacitors on the same PCB layer with the MOSFETs instead of on different layers and using vias to make the connection.</p> <p>Place the inductor terminal to the switching high-side MOSFET drain and low-side MOSFET source terminal as close as possible. Minimize this phase node area to lower the electrical and magnetic field radiation but make this phase node area big enough to carry the current. Place the inductor and the switching MOSFETs on the same layer of the PCB.</p> |
| 11 | UGATE1 | |

| Pin # | Pin Name | Layout Guidelines |
|-------|----------|--|
| 12 | BOOT1 | Switching pin. Place the bootstrap capacitor in general proximity of the controller. Use decent wide trace. Avoid any sensitive analog signal trace from crossing over or getting close. |
| 13 | ADPS | Signal pin. Provides feedback for the system bus voltage. Place the optional RC filter in general proximity of the controller. Run a dedicated trace from system bus to the pin and do not route near the switching traces. |
| 14 | CSIN | <p>Run two dedicated traces with decent width in parallel (close to each other to minimize the loop area) from the two terminals of the adapter current sensing resistor to the IC. Place the Differential mode and common-mode RC filter components in general proximity of the controller.</p> <p>Route the current sensing traces through vias to connect the center of the pads; or route the traces into the pads from the inside of the current sensing resistor. The following drawings show the two preferred ways of routing current sensing traces.</p>  <p style="text-align: center;">CURRENT SENSING TRACES CURRENT SENSING TRACES</p> |
| 15 | CSIP | |
| 16 | ADP | Signal pin. Run a dedicated trace from the ADP side to the pin and do not route near the switching traces. |
| 17 | DCIN | Place the OR diodes and the RC filter in general proximity of the controller. Run the VADP trace and VSYS trace to the OR diodes with decent width. |
| 18 | VDD | Place the RC filter connecting with VDDP pin in general proximity of the controller. Run the trace connecting to VDDP pin with decent width. |
| 19 | FRWEN | Do not route near the switching traces. |
| 20 | RVSEN | No special consideration. |
| 21 | SDA | Digital pins. No special consideration. Run the SDA and SCL traces in parallel. |
| 22 | SCL | |
| 23 | PROCHOT# | Digital pin, open-drain output. No special consideration. |
| 24 | FRWPG | Digital pin, open-drain output. No special consideration. |
| 25 | ADDR0 | Digital pin. No special consideration. |
| 26 | RVSPG | Digital pin, open-drain output. No special consideration. |
| 27 | PROG | Signal pin. Place the PROG programming resistor in general proximity of the controller. |
| 28 | COMPF | Place the compensation components in general proximity of the controller. Avoid any switching signal from crossing over or getting close. |
| 29 | REF | Do not route near the switching traces. Place the REF capacitor in general proximity of the controller. |
| 30 | COMPR | Place the compensation components in general proximity of the controller. Avoid any switching signal from crossing over or getting close. |
| 31 | VOUT | Signal pin. Run a dedicated trace from system side to the pin and do not route near the switching traces. |
| 32 | ADDR1 | Digital pin. No special consideration. |

3.2 ISL95338EVAL1Z Schematic

All NFETs and PFETs are 3x3 size

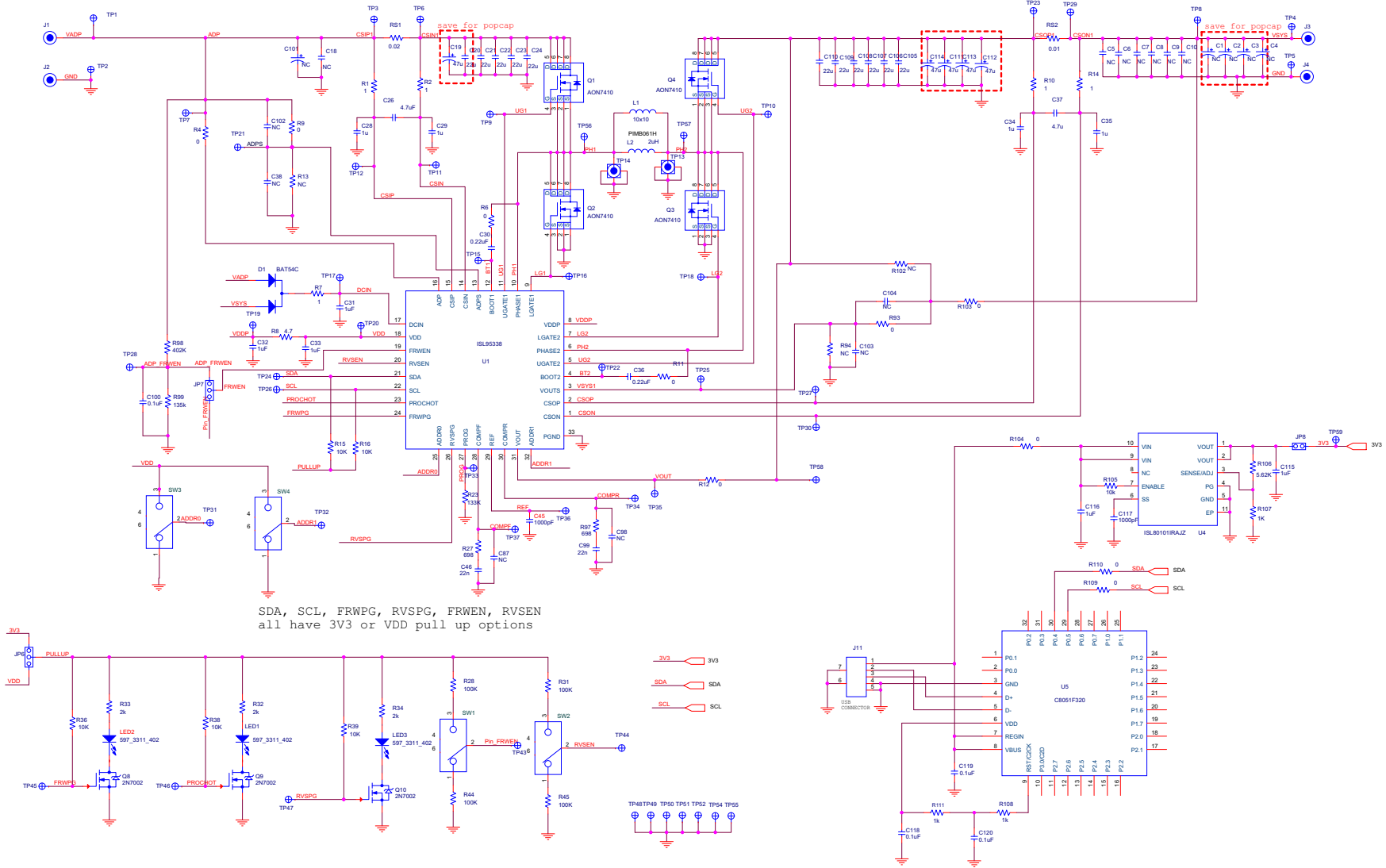

Figure 6. ISL95338EVAL1Z Evaluation Board Schematic

3.3 Bill of Materials

| Reference Designator | Qty | Manufacturer | Part Number | Description |
|---|-----|-------------------------|--------------------------|--|
| SEE LABEL- RENAME BOARD | 1 | IMAGINEERING INC | ISL95338EVAL1ZREVBPCB | PWB-PCB, ISL95338EVAL1Z, REVB, ROHS |
| C19, C111, C112, C113, C114 | 5 | Kemet | 399-3797-2-ND | CAP-POSCAP, SMD, 7.3x4.3x1.9, 47µF, 25V, 20%, 55mΩ, ROHS |
| C45, C82 | 2 | VENKEL | H1045-00102-16V10-T | CAP, SMD, 0603, 1000pF, 16V, 10%, X7R, ROHS |
| C84, C85, C86, C100, | 4 | MURATA | H1045-00104-25V10-T | CAP, SMD, 0603, 0.1µF, 25V, 10%, X7R, ROHS |
| C31, C81, C83, C28, C29, C34, C35, C32, C33 | 9 | MURATA | H1045-00105-25V10-T | CAP, SMD, 0603, 1µF, 25V, 10%, X5R, ROHS |
| C30, C36 | 2 | TDK | H1045-00224-25V10-T | CAP, SMD, 0603, 0.22µF, 25V, 10%, X7R, ROHS |
| C46, C99 | 2 | MURATA | H1045-00472-16V10-T | CAP, SMD, 0603, 0.022µF, 25V, 10%, X7R, ROHS |
| C26, C37 | 2 | VENKEL | H1045-00475-10V10-T | CAP, SMD, 0603, 4.7µF, 10V, 10%, X5R, ROHS |
| C87, C98 | 2 | | H1045-DNP | CAP, SMD, 0603, DNP-PLACE HOLDER, ROHS |
| C20-24, C105-C110 | 9 | TDK | 1276-2908-2-ND | CAP, SMD, 0805, 22µF, 25V, 10%, X5R, ROHS |
| L1 | 1 | CYNTEC CO., LTD. | PIMB063T-2R2MS-01 | PWR CHOKE COIL, SMD, 6.95x6.6, 2.2µH, 10A, 20%, ROHS |
| J1, J3 | 2 | JOHNSON COMPONENTS | 111-0702-001 | CONN-GEN, BIND.POST, INSUL-RED, THMBNUT-GND |
| J2, J4 | 2 | JOHNSON COMPONENTS | 111-0703-001 | CONN-GEN, BIND.POST, INSUL-BLK, THMBNUT-GND |
| TP13, TP14 | 2 | TEKTRONIX | 131-4353-00 | CONN-SCOPE PROBE TEST PT, COMPACT, PCB MNT, ROHS |
| TP1-TP12, TP15-TP37, TP43-TP57 | 50 | KEYSTONE | 5002 | CONN-MINI TEST POINT, VERTICAL, WHITE, ROHS |
| J10 | 1 | MOLEX | 54819-0519 | CONN-USB MINI-B RECEPTACLE, TH, 5CIRCUIT, R/A, ROHS |
| JP6, JP7 | 2 | BERG/FCI | 68000-236HLF-1X3 | CONN-HEADER, 1x3, BREAKAWY 1x36, 2.54mm, ROHS |
| JP4 | 1 | BERG/FCI | 69190-202HLF | CONN-HEADER, 1x2, RETENTIVE, 2.54mm, 0.230x0.120, ROHS |
| JP4-Pins 1-2. | 1 | SULLINS | SPC02SYAN | CONN-JUMPER, SHORTING, 2PIN, BLACK, GOLD, ROHS |
| D1 | 1 | | BAT54C-7-F-T | DIODE-RECTIFIER, SMD, SOT23, 30V, 200mA, DUAL DIODE, ROHS |
| LED1, LED2, LED3 | 3 | DIALIGHT | 597-3311-407NF-T | LED, SMD, 1206, GREEN, 75mW, 3mcd, 567nm, ROHS |
| U2 | 1 | SILICON LABORATORIES | C8051F320-GQ/PROG-REV.02 | IC-USB MICROCONTROLLER, 32P, LQFP, PROGRAMMED, ROHS |
| U3 | 1 | INTERSIL | ISL80101IRAJZ | IC-ADJ.V, 1A LDO REGULATOR, 10P, DFN, 3X3, ROHS |
| U1 | 1 | INTERSIL | ISL95338HRZ | C-NOTEBOOK BATTERY CHARGER, 32P, QFN, 4x4, ROHS |
| Q8, Q9, Q10 | 3 | DIODES, INC. | 2N7002-7-F-T | TRANSISTOR, N-CHANNEL, 3LD, SOT-23, 60V, 115mA, ROHS |

| Reference Designator | Qty | Manufacturer | Part Number | Description |
|--|-----|---------------------------------|----------------------|--|
| Q1, Q2, Q3, Q4 | 4 | VISHAY | SISA14DN-T1-GE3-T | TRANSISTOR-MOS, N-CHANNEL, 8P, PWRPAK, 30V, 20A, ROHS |
| R1, R2, R7, R10, R14 | 5 | YAGEO | H2511-00020-1/10W1-T | RES, SMD, 0603, 2Ω, 1/10W, 1%, TF, ROHS |
| R8 | 1 | VENKEL | H2511-004R7-1/10W1-T | RES, SMD, 0603, 4.7Ω, 1/10W, 1%, TF, ROHS |
| R4, R6, R11, R12, R103, R84, R85, R86, R9, R9 | 11 | VENKEL | H2511-00R00-1/10W-T | RES, SMD, 0603, 0Ω, 1/10W, TF, ROHS |
| R83, R87, R88 | 3 | PANASONIC | H2511-01001-1/10W1-T | RES, SMD, 0603, 1k, 1/10W, 1%, TF, ROHS |
| R15, R16, R36, R38, R39, R81 | 6 | VENKEL | H2511-01002-1/10W1-T | RES, SMD, 0603, 10k, 1/10W, 1%, TF, ROHS |
| R13 | 1 | YAGEO | 311-1.00MHRTR-ND | RES SMD 1MΩ 1% 1/10W 0603 |
| R28, R31, R44, R45 | 4 | VENKEL | H2511-01003-1/10W1-T | RES, SMD, 0603, 100k, 1/10W, 1%, TF, ROHS |
| R23 | 1 | VENKEL | H2511-01333-1/10W1-T | RES, SMD, 0603, 133k, 1/10W, 1%, TF, ROHS |
| R27, R97 | 2 | PANASONIC | H2511-06980-1/10W1-T | RES, SMD, 0603, 698, 1/10W, 1%, TF, ROHS |
| R32, R33, R34 | 3 | YAGEO | H2511-02200-1/10W1-T | RES, SMD, 0603, 2kΩ, 1/10W, 1%, TF, ROHS |
| R98 | 1 | PANASONIC | H2511-04023-1/10W1-T | RES, SMD, 0603, 402k, 1/16W, 1%, TF, ROHS |
| R82 | 1 | PANASONIC | H2511-05621-1/10W1-T | RES, SMD, 0603, 5.62k, 1/10W, 1%, TF, ROHS |
| RS2 | 1 | VISHAY/DALE | WSLP1206R0100FEA-T | RES-CURR.SENSE, SMD, 1206, 0.01Ω, 1W, 1%, 75ppm, ROHS |
| R99 | 1 | PANASONIC | H2511-04023-1/10W1-T | RES SMD 135kΩ 0.1% 1/10W 0603 |
| RS1 | 1 | VISHAY/DALE | WSLP1206R0200FEA-T | RES-CURR.SENSE, SMD, 1206, 0.02Ω, 1W, 1%, 75ppm, ROHS |
| SW1, SW2, SW3, SW4 | 4 | ITT INDUSTRIES/ C&K DIVISION | GT11MSCBE-T | SWITCH-TOGGLE, SMD, 6PIN, SPDT, 2POS, ON-NONE-ON, ROHS |
| C101 C18, C102 C38, C5-C10, C1-C4, C104, C103, C39 | DNP | | | |
| R3, R94, R13, R102 | DNP | | | |
| TP38-TP42 | DNP | | | |
| C27 | DNP | | | |
| AFFIX TO BACK OF PCB | 1 | INTERSIL | LABEL-DATE CODE | LABEL-DATE CODE_LINE 1: YRWK/REV#, LINE 2: BOM NAM |
| RENAME PCB TO: ISL95338EVAL1Z. | | INTERSIL | LABEL-RENAME BOARD | LABEL, TO RENAME BOARD |

3.4 Board Layout

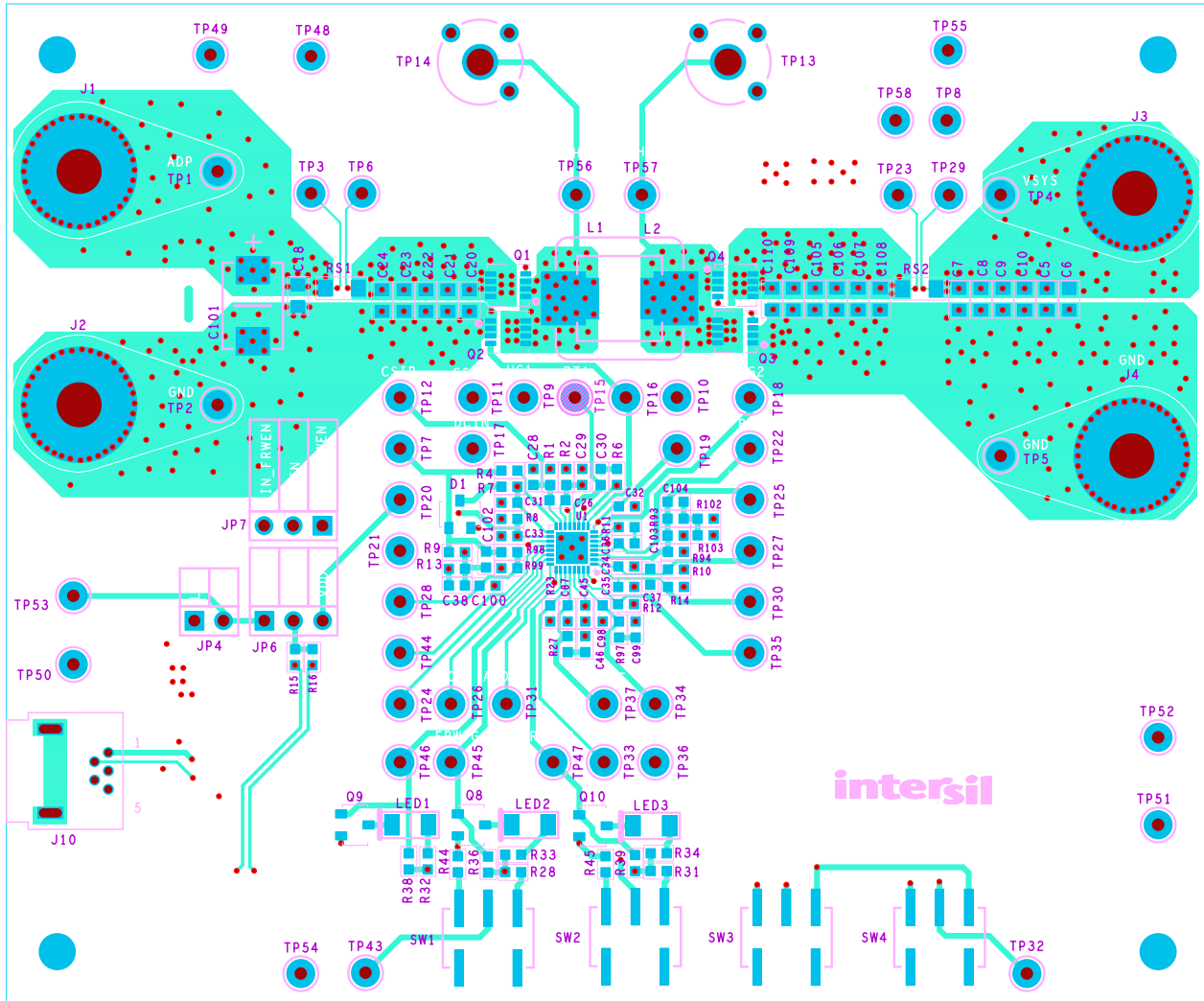

Figure 7. Top Layer

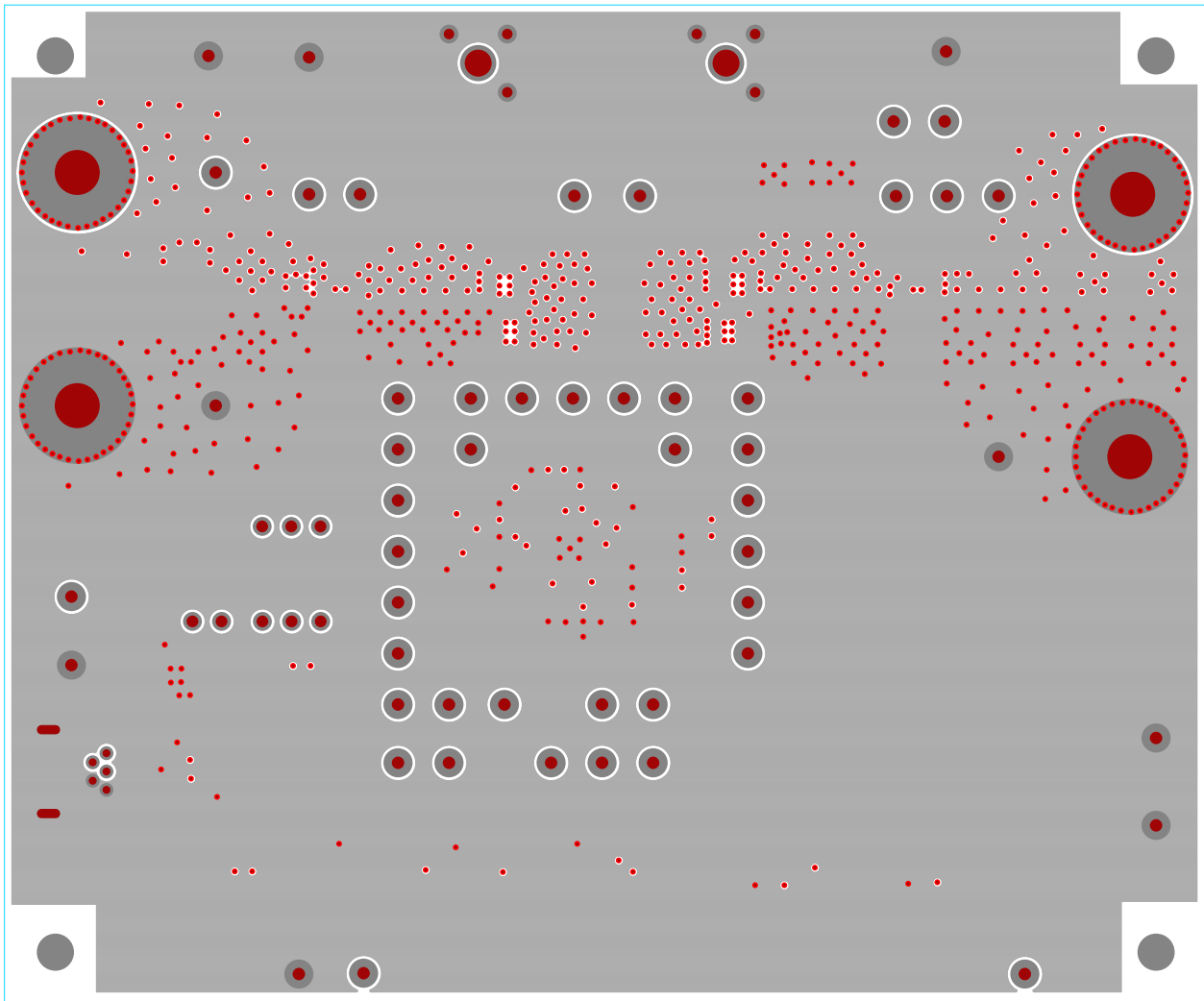

Figure 8. Inner Layer 1

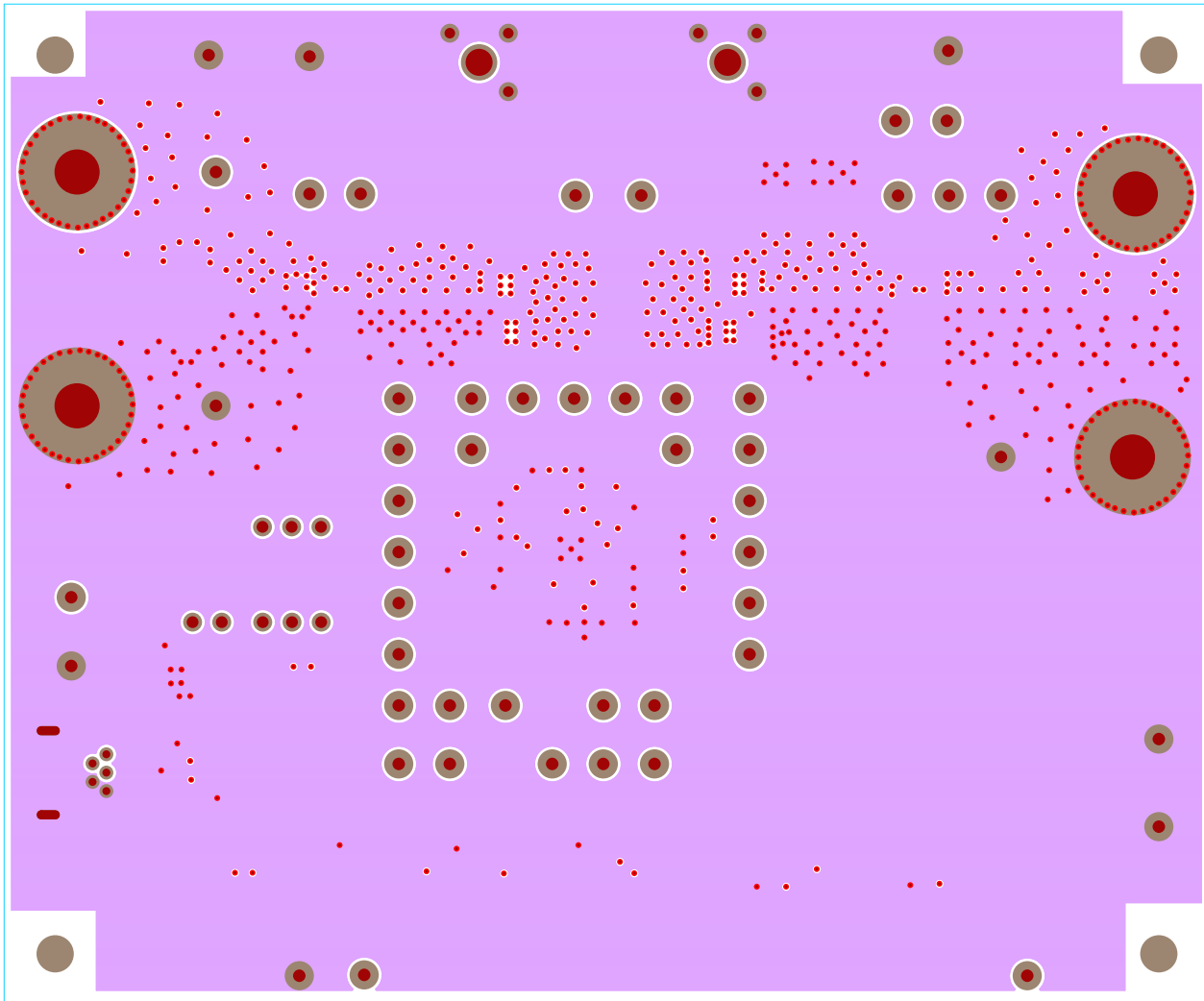

Figure 9. Inner Layer 2

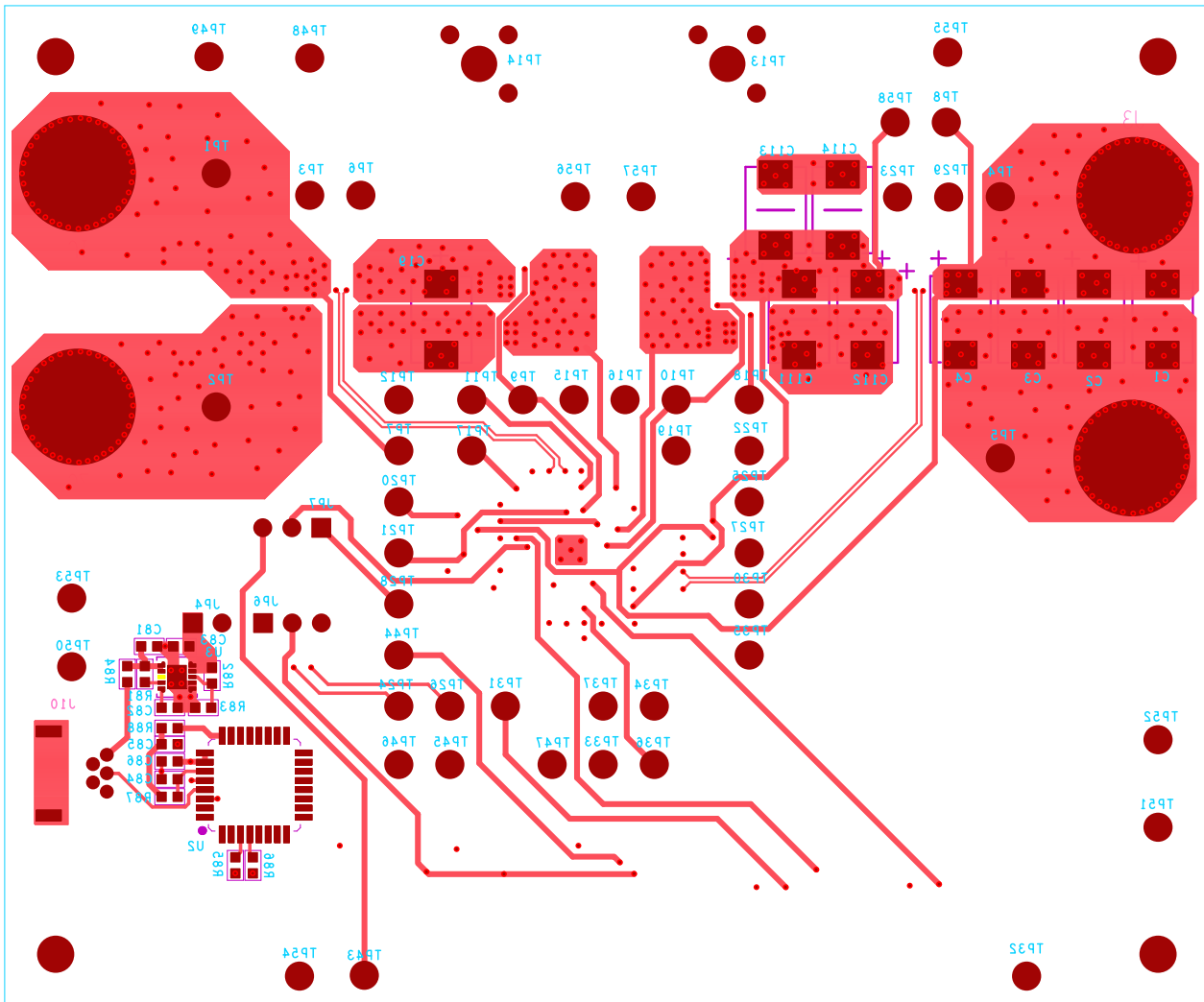

Figure 10. Bottom Layer

4. Typical Performance Curves

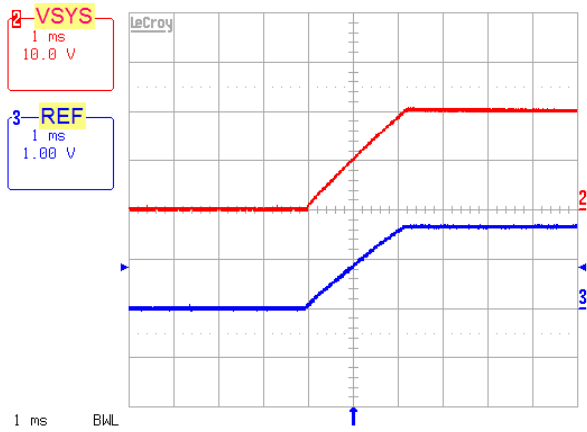

Figure 11. Forward Mode Soft-Start, 12V_{ADP}, 20V_{SYS}

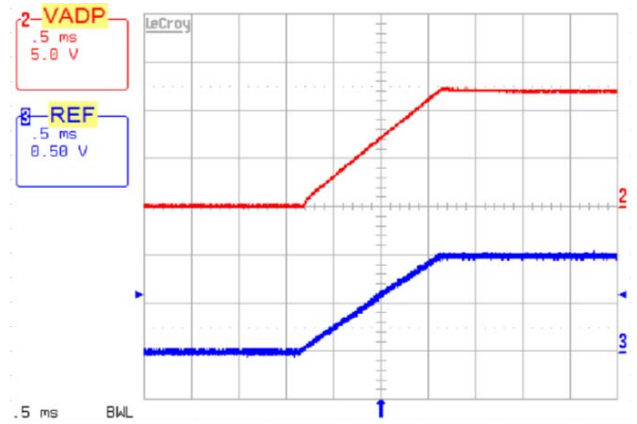

Figure 12. Reverse Mode, Soft-Start, 12V_{ADP}, 5V_{SYS}

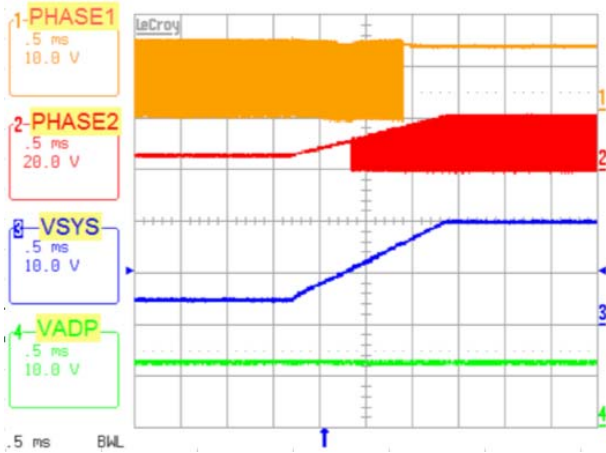

Figure 13. V_{SYS} Voltage Ramps Up in Forward Mode, Buck -> Buck-Boost -> Boost Operation Mode Transition

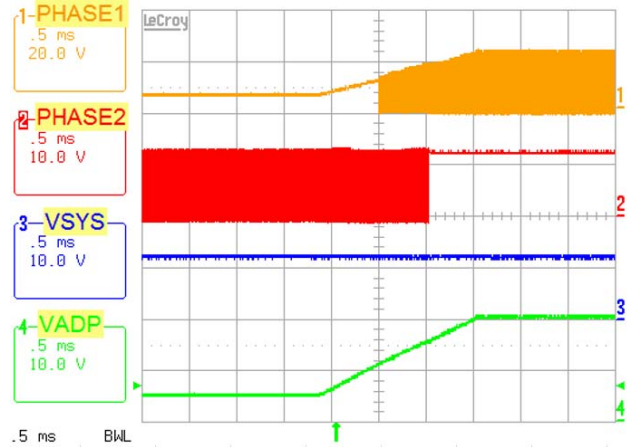

Figure 14. ADP Voltage Ramps Up in Reverse Mode, Buck -> Buck-Boost -> Boost Operation Mode Transition

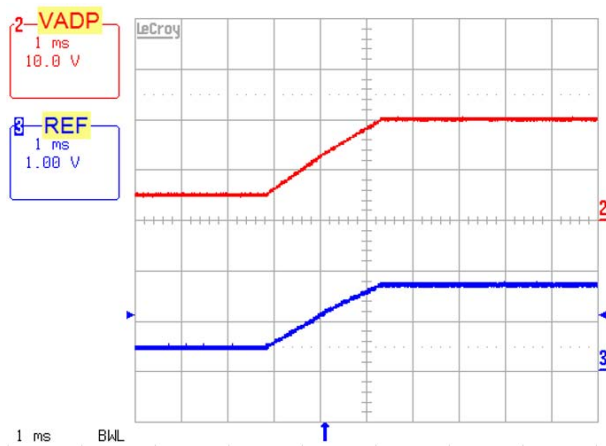

Figure 15. Reverse Mode, 5V_{ADP} to 20V_{ADP}

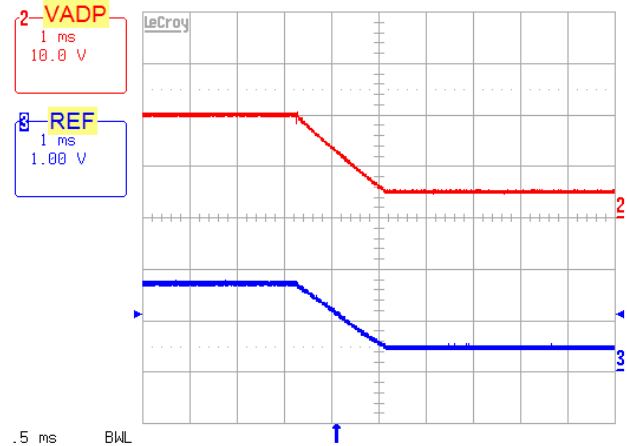

Figure 16. Reverse Mode, 20V_{ADP} to 5V_{ADP}

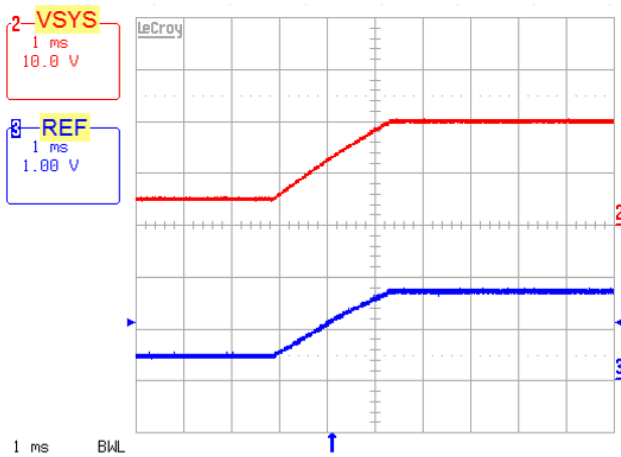

Figure 17. Forward Mode, 5V_{sys} to 20V_{sys}

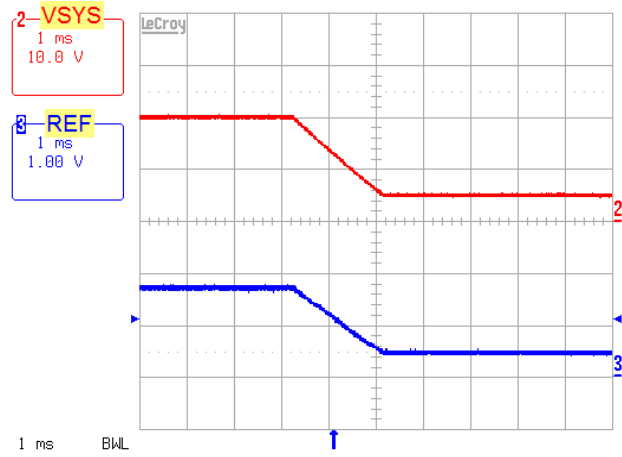

Figure 18. Forward Mode, 20V_{sys} to 5V_{sys}

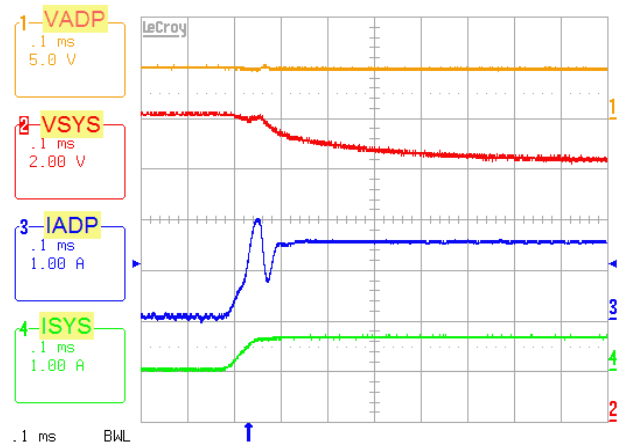

Figure 19. Forward Mode, Output Voltage Loop to ADP Current Loop Transition. 5V_{ADP}, 12V_{sys}, System Load 0A to 0.65A Step, ADP Current Limit = 1.5A

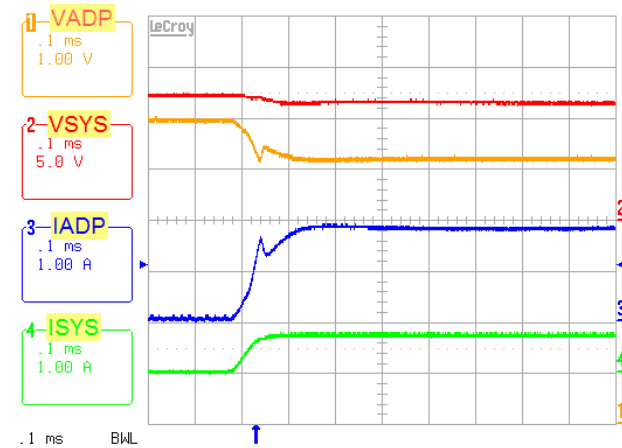

Figure 20. Forward Mode, Output Voltage Loop to Adapter Voltage Loop Transition. 6V_{ADP}, Input Voltage Limit = 5.12V, 12V_{sys}, System Load 0A to 0.78A Step, System Current Limit = 5A, Input Current Limit = 5 A

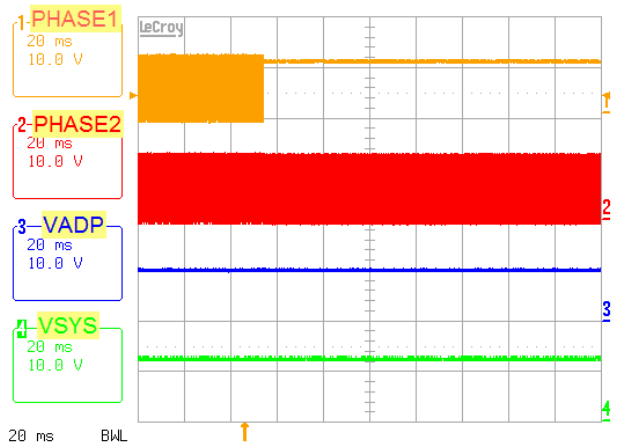

Figure 21. Forward Mode, Force Buck-Boost Mode to Boost Mode. 10V_{ADP}, 12V_{sys}

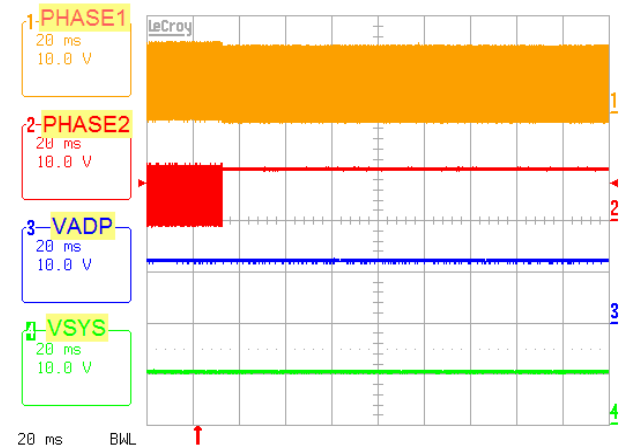

Figure 22. Reverse Mode, Force Buck-Boost Mode to Boost Mode. 12V_{ADP}, 10V_{sys}

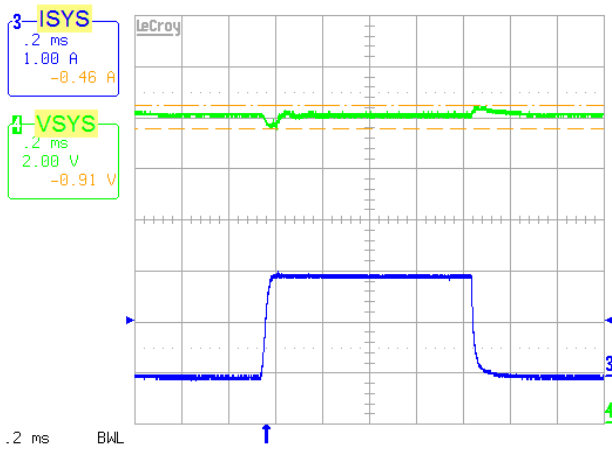

Figure 23. Forward Mode, 5V_{ADP}, 12V_{SYS}, 0-2A Transient Load

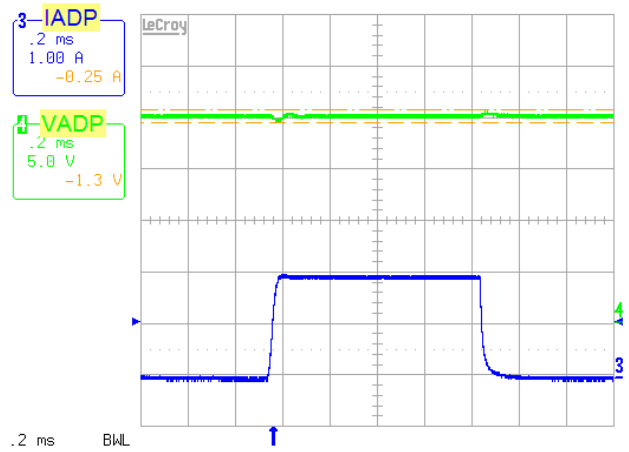

Figure 24. Reverse Mode, 20V_{ADP}, 12V_{SYS}, 0-2A Transient Load

5. Revision History

| Rev. | Date | Description |
|------|--------------|-----------------|
| 0.00 | Aug 17, 2017 | Initial release |

© Copyright Intersil Americas LLC 2017. All Rights Reserved.
All trademarks and registered trademarks are the property of their respective owners.

Intersil Corporation reserves the right to make changes in circuit design, software and/or specifications at any time without notice. Accordingly, the reader is cautioned to verify that the document is current before proceeding.

For information regarding Intersil Corporation and its products, see www.intersil.com

ISL95338EVAL1Z